



SEAMASTER

PRODUCT CATALOGUE

SUPPLIER OF DURABLE PRODUCTS FOR HARSH ENVIRONMENTS





Seamaster provides a wide range of products and services to support the aquaculture, commercial fishing, and marine industries.

With the world's ever-growing demand for seafood, our unwavering commitment is to equip our customers, who brave the ocean's challenges day in and day out, with premium, durable products to ensure their success.

Seamaster is the trusted partner of choice for a diverse clientele, including aquaculture and marine operators, commercial and sport fishermen, processing factories and retail, all of whom rely on us for quality fishing, marine, and aquaculture solutions.

Within our extensive catalogue, you'll find a comprehensive range of products tailored to the specific needs of the aquaculture, commercial fishing, and marine industries. Whether you're involved in the tuna, salmon, or kingfish sectors, oyster and mussel farming, prawn fishing, rock lobster and longline operations, sport and game fishing, processing facilities, or retail, Seamaster has you covered.

Our streamlined logistics ensure efficient equipment delivery from manufacturers, minimizing freight costs. In addition to supplying high quality fishing gear and tackle, we work closely with our customers to supply the aquaculture industry with:

- Fish pens
- Mooring systems & hardware
- Rope
- Net weights
- Hooks
- Boating accessories
- Floats & lease markers
- Mortality collectors
- Safety & Personal Protective Equipment

We also offer additional services, including rope splicing, custom-made rigs, and mooring design and implementation. Our rotational moulded products, such as bins, floats, buoys, markers, and sea cage stanchions, are designed for various marine and aquaculture applications.

Our in-house splicing specialists stand ready to assist with custom rope orders, utilizing materials like nylon, polypropylene, and polyester to suit projects of any size, from intricate mooring systems to rigging up a cray pot buoy or vessel mooring line. We offer a wide range of rope thicknesses and lays to meet your specific requirements.

At Seamaster, our dedicated, skilled, and knowledgeable team spans Tasmania and South Australia, boasting years of experience in the fishing and marine industry. Whether you need rope splicing expertise, a complete mooring system installation, or insider tips on where to land the biggest tuna, you can trust our passionate team to provide the best advice and assistance in the industry.

Choose Seamaster as your trusted supplier for durable products for harsh environments to meet all your aquaculture, commercial fishing, marine and mooring needs.

CONTENTS

- 01 Anodes** 006
 - > Cray Pot
 - > Rudder
 - > Block
 - > Block with Strap
 - > Engine Anode
 - > Shaft
- 02 Boating Hardware & General Chandlery** 012
 - > Marine Pumps
 - > Marine Engine Fuel Fittings
 - > Skin Fittings, Bungs and Scuppers
 - > Hose
 - > Oars, Paddles and Boat Hooks
 - > Marine Sealants
 - > Tube Clips
 - > Cleats and Bollards
 - > Engine Controls and Cables
 - > Tapes and Miscellaneous Items
 - > Winches and Trailer Rollers
 - > Hinges and Latches
 - > Fishing Rod Holders
 - > Cable Ties
 - > Inspection Ports
- 03 Chemicals & Cleaning Products** 022
 - > Chemical Cleaners
 - > Lubricants
 - > Cleaning Accessories
 - > Jotun Paint
 - > West System Epoxy Resin
- 04 Fishing Gear** 026
 - > Cray Pots and Accessories
 - > Crimps
 - > Crimping Tools
 - > Crimping Dies
 - > Gaffs, Spears, Tail Ropes and Landing Nets
 - > Asano Equipment
 - > Norwegian Boss Equipment
 - > Hooks
 - > Knives and accessories
 - > Underwater / Strobe Lights
 - > Luminous Beads, Sleeves and Tubing
 - > Lures
 - > Monofilament and Braid
 - > Other Monofilament Line Products
 - > Netting
 - > Rods and Reels
 - > Rigging
 - > Professional Squid Gear
 - > Sinkers
 - > Tuna Oil
 - > Terminal Tackle
 - > Swivels
 - > Stainless Steel Wire
- 05 Floats & Fenders** 058
 - > Mooring Buoys
 - > Deepsea Pressure Floats
 - > Aquaculture Floats and Markers
 - > Foam Floats
 - > QE NZ Floats
 - > Polyform Inflatable
 - > Marine Construction Float
 - > Heavy Duty Ship Fenders
 - > Fender Covers
 - > Accessories
- 06 Lighting** 064
 - > Hand Held Lights
 - > Navigation Lights
 - > Solar Powered Navigation Aids
 - > Fixed Work and Spotlights
- 07 Electrical** 068
 - > Radio and Aerials
 - > Batteries
 - > Electric Winches
 - > Switches, Sockets and Accessories
- 08 Mooring & Rigging Hardware** 072
 - > Anchors
 - > Chain
 - > Shackles
 - > Stainless Steel Hardware
 - > Thimbles
- 09 New Era Tanks** 088
 - > Petrol Tanks 23 - 150 Litre
 - > Diesel Tanks 23 - 150 Litre
 - > Water Tanks 35 - 150 Litre
 - > Tank Extras
 - > Live Bait Tanks
 - > Berley Buckets
- 10 Protective Clothing** 110
 - > Aprons
 - > Headwear
 - > Eyewear
 - > Gloves
 - > Boots and Gumboots
 - > Waders
 - > Wet Weathers
 - > Waterproof Gear Bag
- 11 Rope & Cordage** 128
 - > 3 Strand
 - > 8 Strand
 - > 12 Strand
 - > Lead Core
 - > Braid
 - > Twine
 - > Working Tools
- 12 Safety** 144
 - > General Safety Equipment
 - > Flares
 - > Life Jackets
 - > Hydrostatic Release Units for Life Rafts
- 13 Fish Pen & Mooring Equipment** 150
 - > Bird Net Stands
 - > Anchors for Mooring Systems
 - > Marine Markers
 - > Mooring Blocks
 - > Grid Floats
 - > Airfoss - Mortality Removal Unit
 - > Net Weights and Diverless Net Weight Hooks
 - > Quadrants
 - > Shackles and Chain
 - > Mooring Grid System Ropes
 - > Stanchions
 - > Tow Floats
 - > Thimbles
- 14 Shellfish** 168
 - > Hexcyl Products & Mesh
 - > Mussel Rope
- 15 Storage** 174
 - > Collapsible Bins
 - > Insulated Bins
 - > Non-Insulated Bins, Buckets, Crates, Trays and Drums
 - > Pallets
 - > Polybench
 - > Spill Bunds
- 16 Seamaster Premium Products** 190
 - > Become a stockist



01 Anodes

02 Boating Hardware & General Chandlery

03 Chemicals & Cleaning Products

04 Fishing Gear

05 Floats & Fenders

06 Lighting

07 Electrical

08 Mooring & Rigging Hardware

09 New Era Tanks

10 Protective Clothing

11 Rope & Cordage

12 Safety

13 Fish Pen & Mooring Equipment

14 Shellfish

15 Storage

16 Seamaster Premium Products

01 ANODES

- > Cray Pot
- > Rudder
- > Block
- > Block with Strap
- > Engine Anode
- > Shaft

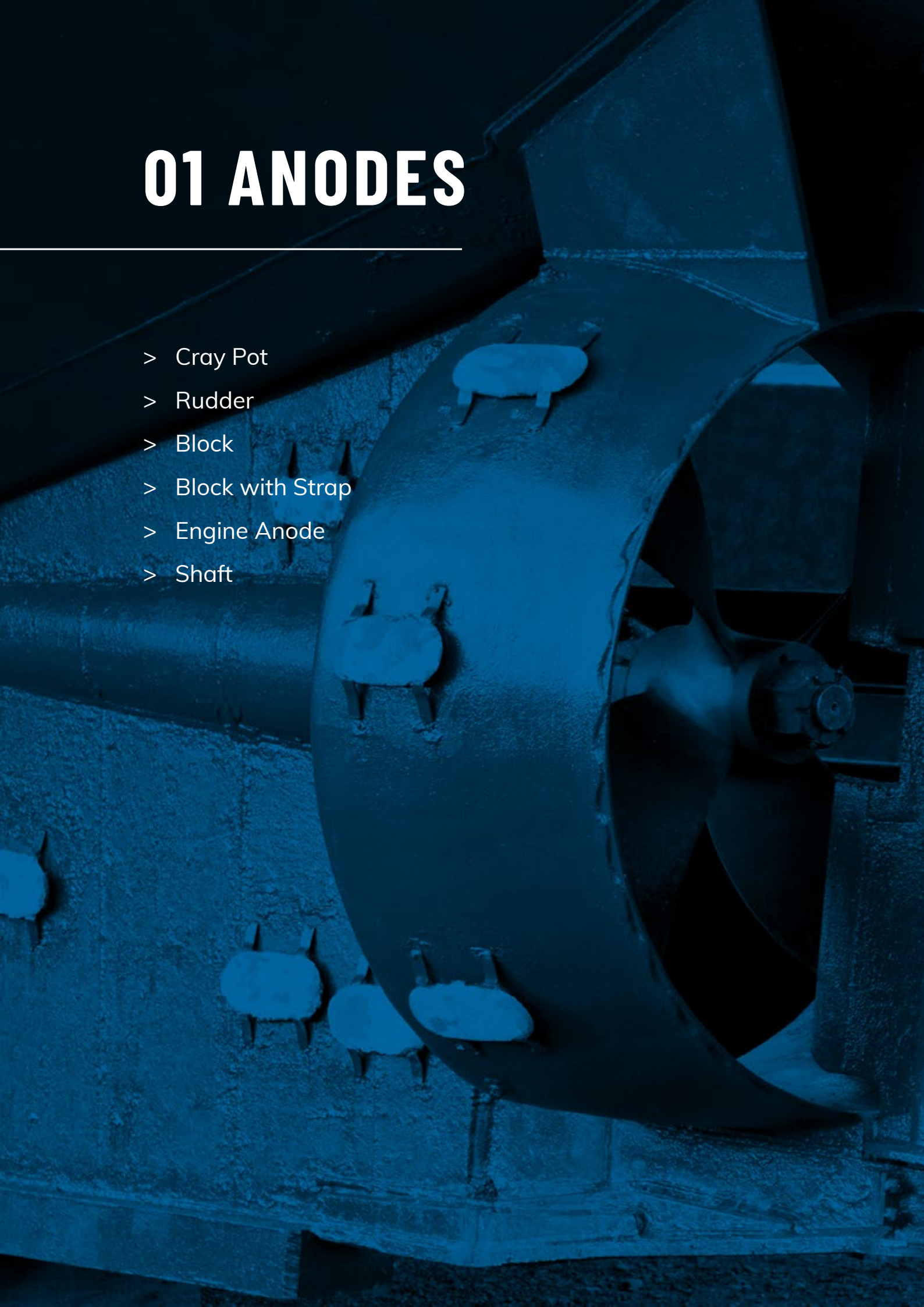

Seamaster stocks an extensive range of anodes to suit many applications.

Shaft and pencil anodes, block anodes with or without straps, rudder anodes and anodes for thrusters, are used for cathodic protection of your vessel.

- Protect your craft from harsh environments
- Made in Australia from quality materials

CRAY POT



PRODUCT CODE	DESCRIPTION	WIRE LENGTH	LENGTH	WEIGHT (KG)	INSERT DIMENSIONS
AMAC007	Cray pot	400mm	175mm	1.0	Gal wire 2.5mm
AND058	Cray pot	500mm	220mm	2.1	Gal wire 3mm
AND002	Alloy pot	500mm	220mm	0.8	Gal wire 3mm

RUDDER



PRODUCT CODE	DESCRIPTION	DIAMETER	HEIGHT	NOMINAL GROSS WEIGHT (PAIR) (KG)
AMAC009	Rudder (pair)	70mm	19mm	0.32
AMAC010	Rudder (pair)	100mm	21mm	0.64
AMAC011	Rudder (pair)	120mm	25mm	1.2

BLOCK



PRODUCT CODE	DESCRIPTION	DIMENSIONS	NOMINAL GROSS WEIGHT (KG)
AMAC002	Teardrop	85mm L, 42mm W, 15mm H	0.2



PRODUCT CODE	DESCRIPTION	DIMENSIONS	NOMINAL GROSS WEIGHT (KG)
AMAC012	Rectangle	150mm L, 70mm W, 35mm H	2.1
AMAC020	Rectangle	150mm L, 75mm W, 25mm H	2.0



PRODUCT CODE	DESCRIPTION	DIMENSIONS	NOMINAL GROSS WEIGHT (KG)	INSERT DIMENSIONS
AMAC014	Oval	315mm L, 130mm W, 35mm H	6.4	150mm ctrs



PRODUCT CODE	DESCRIPTION	DIMENSIONS	NOMINAL GROSS WEIGHT (KG)
AMAC021	Square	75mm L, 75mm W, 25mm H	1.0
AMAC019	Square	150mm L, 150mm W, 25mm H	4.0



PRODUCT CODE	DESCRIPTION	DIMENSIONS	NOMINAL GROSS WEIGHT (KG)
AMAC024	Square with hole	75mm L, 75mm W, 25mm H	1.1



PRODUCT CODE	DESCRIPTION	DIMENSIONS	NOMINAL GROSS WEIGHT (KG)	INSERT DIMENSIONS
AMAC037	Rectangle with holes	200mm L, 100mm W, 21mm H	2.8	55dia dish
AMAC039	Rectangle with holes	300mm L, 100mm W, 50mm H	7.8	260x40x6 MS

BLOCK WITH STRAP

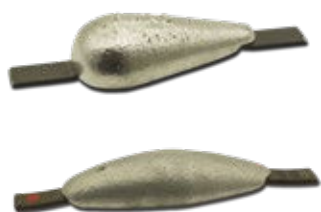

PRODUCT CODE	DESCRIPTION	DIMENSIONS	NOMINAL GROSS WEIGHT (KG)	INSERT DIMENSIONS
AMAC003	Teardrop	140mm L, 62mm W, 32mm H	1.0	240x25x3 MS
AND013	Teardrop	140mm L, 62mm W, 32mm H	1.0	240x25x3 MS
AMAC004	Teardrop	160mm L, 80mm W, 40mm H	1.7	260x25x3 MS
AND016	Teardrop	160mm L, 80mm W, 40mm H	1.7	260x25x3 MS
AMAC005	Teardrop	220mm L, 75mm W, 40mm H	2.2	320x25x6 MS
AND017	Teardrop	220mm L, 75mm W, 40mm H	2.2	320x25x6 MS



PRODUCT CODE	DESCRIPTION	DIMENSIONS	NOMINAL GROSS WEIGHT (KG)	INSERT DIMENSIONS
PL0106 CDZ8-10S	Oval	250mm L, 125mm W, 38mm H	7	405x32x5mm
AMAC015	Oval	200mm L, 150mm W, 30mm H	8.6	440x40x6 MS
AMAC017	Oval	350mm L, 150mm W, 35mm H	10.6	500x40x6 MS
AMAC016	Oval	300mm L, 150mm W, 50mm H	12.0	440x40x6 MS



PRODUCT CODE	DESCRIPTION	DIMENSIONS	NOMINAL GROSS WEIGHT (KG)	INSERT DIMENSIONS
AMAC027	Square	75mm L, 75mm W, 25mm H	1.0	275x25x3 MS
AND005	Square	155mm L, 155mm W, 25mm H	4.0	275x25x3 MS
AMAC025	Square	150mm L, 150mm W, 28mm H	4.1	260x25x3 MS



PRODUCT CODE	DESCRIPTION	DIMENSIONS	NOMINAL GROSS WEIGHT (KG)	INSERT DIMENSIONS
AMAC026	Rectangle	150mm L, 75mm W, 25mm H	2.1	250x25x6 MS
AMAC029	Rectangle	285mm L, 80mm W, 40mm H	5.0	135x25x6 MS

ENGINE ANODE



PRODUCT CODE	DESCRIPTION	THREAD	OVERALL LENGTH (MM)	EXPOSED LENGTH (MM)	WEIGHT (g)
AND055	Anode Only CDZ9-004	7/16" UNC	63	50	70
AND056	Anode Only CDZ9-035	3/8" UNC	62	52	40
AND057	Anode Only CDZ9-038	1/2" UNC	99	86	160
AND064	Anode Only CDZ9-033	5/16" UNC	54	44	20
AND070	Anode Only CDZ9-009	5/8" UNC	57	44	100
AND079	Anode Only CDZ9-001	M-8	41	30	70
AND080	Anode Only CDZ9-003	1/4" UNC	69	57	30
AND081	Anode Only CDZ9-005	3/8" UNC	76	53	100
AND082	Anode Only CDZ9-006	5/8" UNC	97	82	180
AND086	Anode Only CDZ9-038	1/2" UNC	67	51	110

PRODUCT CODE	DESCRIPTION	THREAD	OVERALL LENGTH (MM)	EXPOSED LENGTH (MM)	WEIGHT (g)
AND071	w/ Brass Plug CDZ9-032	P-1/4" BSP A-5/16" UNC	60	44	40
AND083	w/ Brass Plug CDZ9-034	P-3/8" BSPT A-3/8" UNC	73	52	70
AND084	w/ Brass Plug CDZ9-036	P-1/2" BSPT A-7/16" UNC	76	51	130
AND085	w/ Brass Plug CDZ9-037	P-3/4" BSPT A-1/2" UNC	78	51	210
AND096	w/ Brass Plug CDZ9-063	P-1/8" BSPT A-1/4" UNC	62	48	20

SHAFT



PRODUCT CODE	DESCRIPTION	INSIDE DIAMETER (MM)	OUTSIDE DIAMETER (MM)	ANODE LENGTH (MM)	NOMINAL GROSS WEIGHT (KG)
AND018	1"	25.40	58	52	0.47
AND019	1" Donut	25.40	64	33	0.53
AND020	1 1/8"	28.44	70	64	1.00
AND021	1 1/4"	31.75	70	64	0.95
AND022	1 3/8"	34.80	70	64	0.90
AND023	1 1/2"	38.10	70	64	0.80
AND024	1 1/2" Donut	38.10	76	33	0.65
AND025	1 3/4"	44.45	84	68	1.15
AND026	2" Heavy Duty	50.80	103	120	4.60
AND027	2 1/4"	57.15	103	120	4.30
AND028	2 1/2"	63.50	103	120	3.70
AND029	2 3/4"	69.85	116	130	5.60
AND030	3"	76.20	116	130	5.00
AND031	3 1/2"	88.90	138	164	8.80
AND032	3/4"	19.05	58	52	0.55
AND033	3/4" Donut	19.05	54	25	0.30
AND034	7/8"	22.09	58	52	0.50
AND087	1 3/4" Donut	44.45	100	35	1.40
AND060	2"	50.80	64	68	1.15
AND089	50mm	50.00	84	68	1.60

02 BOATING HARDWARE & GENERAL CHANDLERY

- > Marine Pumps
- > Marine Engine Fuel Fittings
- > Skin Fittings, Bungs and Scuppers
- > Hose
- > Oars, Paddles and Boat Hooks
- > Marine Sealants
- > Tube Clips
- > Cleats and Bollards
- > Engine Controls and Cables
- > Tapes and Miscellaneous Items
- > Winches and Trailer Rollers
- > Hinges and Latches
- > Fishing Rod Holders
- > Cable Ties
- > Inspection Ports

Through its vast supplier network, Seamaster has access to an enormous range of marine chandlery items, boat hardware and fittings to keep your vessel in service and operational.

Listed below are a range of common items that are kept in stock for your convenience. If what you are looking for is not listed, please ask our sales staff and they can source it for you.

MARINE PUMPS

A large range of all major brand pumps to suit many different liquid transfer applications.



BHW619

Jabsco Diesel Transfer
50LPM 24V
Inlet/Outlet 25mm



BHW586

Jabsco Oil Change System
12/24V
Inlet/Outlet 13mm



PL1576

Rule pump
12V
360Gph



PL1577

Rule pump
12V
500Gph



PL1579

Rule pump
12V
800Gph



PL1578

Rule pump
24V
500Gph



PL1580

Rule pump
24V
800Gph



BHW648

Rule Bilge Pump
1100Gph 12V
Inlet/Outlet 28mm



BHW326

Rule Bilge Pump
1500Gph 12V
Inlet/Outlet 28mm



BHW485

Rule Bilge Pump
1500Gph 24V
Inlet/Outlet 28mm



BHW486

Rule Bilge Pump
2000Gph 12V
Inlet/Outlet 28mm



BHW487

Rule Bilge Pump
2000Gph 24V
Inlet/Outlet 28mm



BHW892

Rule Bilge Pump Auto
2000Gph 12V
Inlet/Outlet 28mm



BHW318

Rule Inline Submersible
IL200 12LPM 12V
Inlet/Outlet 13mm



BHW338

Rule Float Switch
Standard
14amp 12-24V



BHW488

Rule Float Switch
Super
20amp 12-36V



BHW641

Seaflo Bilge Pump
500Gph 12V
Inlet/Outlet 20mm



BHW880

Seaflo Bilge Pump
750Gph 12V
Inlet/Outlet 20mm



BHW643

Seaflo Bilge Pump Auto
750Gph 12V
Inlet/Outlet 20mm



BHW642

Seaflo Bilge Pump
1100Gph 12V
Inlet/Outlet 28mm

					
BHW852	BHW644	BHW645	BHW316	BHW502	BHW460
Seaflo Bilge Pump 1500Gph 12V Inlet/Outlet 28mm	Seaflo Bilge Pump 2000Gph 24V Inlet/Outlet 28mm	Seaflo Float Switch 20amp 12-24V	AAA Manual Bilge Pump 35LPM Inlet/Outlet 25/38mm	AAA Manual Bilge Pump S/S Handle 55LPM Inlet/Outlet 25/38mm	Whale Manual Bilge Pump Gusher Urchin 47LPM Inlet/Outlet 22/38mm
					
BHW639	GCH211	BHW513	BHW425	BHW492	BHW646
Whale Manual Bilge Pump Gusher 30 117LPM Inlet/Outlet 38mm	Beckson Manual Bilge Pump 16" 20LPM Inlet/Outlet 50mm	Jabsco Pressure Pump Parmax 2.9 2.9GPM 12V Inlet/Outlet 13mm	Jabsco Washdown Kit Parmax 4.0 4.0GPM 12V Inlet/Outlet 13mm	Jabsco Washdown Pump Hotshot 6 6.0GPM 12V Inlet/Outlet 20mm	Seaflo Washdown Kit 5 5.0GPM 12V Inlet/Outlet 13mm

MARINE ENGINE FUEL FITTINGS

Fuel lines, filters, fillers and associated connections to fit most makes and models of marine outboard and inboard engines.

					
BHW250	BHW252	GCH063	GCH059	BHW253	BHW256
Fuel Line Fitting Mercury '99 to date	Fuel Line Fitting Mercury / Yamaha Old style	Fuel Line Fitting Evinrude / Johnson OMC Style	Fuel Line Assembly Standard No Fittings	Fuel Line Assembly Premium No Fittings	Fuel Tank Fitting Mercury '99 to date
					
BHW257	BHW255	BHW900	BHW901	GCH047	GCH048
Fuel Tank Fitting Mercury / Yamaha Old Style	Fuel Tank Fitting Evinrude / Johnson OMC Style	Fuel line Primer Bulb 8/10mm Premium	Fuel Line Primer Bulb 8mm Standard	Fuel Filter Assembly alloy Head / Clear Bowl Merc style	Fuel Filter to Suit Clear Bowl Merc Style
					
GCH046	BHW544	GCH123	BHW011	PL0479	BHW371
Outboard Motor Flushers Large Rectangular	Outboard Motor Flushers Small Round	Outboard Motor Flushers Twin Intake	Deck Fuel Filler 50mm Black Nylon	Deck Fuel Filler 38mm Black Nylon	Fuel Breather 16mm Black Nylon

SKIN FITTINGS, BUNGS AND SCUPPERS

Available in white nylon and stainless steel, used for water discharge outlets through the hull.



BHW656
Large Alloy Scupper

BHW404	BHW405	BHW309	BHW406	BHW551	BHW552
Skin Fitting White Acetal Nylon 13mm	Skin Fitting White Acetal Nylon 16mm	Skin Fitting White Acetal Nylon 19mm	Skin Fitting White Acetal Nylon 25mm	Skin Fitting White Acetal Nylon 32mm	Skin Fitting White Acetal Nylon 38mm
BHW319	BHW320	BHW317	BHW799	BHW424	PL0503
Skin Fitting Stainless Steel 19mm	Skin Fitting Stainless Steel 25mm	Standard Coarse Thread Bung Complete	Standard Coarse Thread Bung Only	Large Bung Only TENOB	Medium Bung Complete TENOB 25mm

HOSE









Quality PVC and rubber hoses for water, air and fuel. Manufactured to meet appropriate standards where required.



HSP041
Drinking Water 12mm

HSP036	HSP037	HSP038	HSP039	HSP040	HSP042
Flexible Bilge 20mm	Flexible Bilge 25mm	Flexible Bilge 28mm	Diving Air 8mm	Diving Air 10mm	Fuel Filler 38mm
HSP043	HSP044	HSP045	HSP046	HSP047	HSP048
Fuel Filler 51mm	Fuel Line 8mm	Fuel Line 10mm	Wash Down 25mm	Wash Down 32mm	Wash Down 38mm

OARS, PADDLES AND BOAT HOOKS

					
			GCH035	BHW314	BHW744
Boat Hook Heavy Duty Timber 1.8m			Boat Hook Head Only Black Nylon 25mm		Boat Hook Head Only Black Nylon 30mm
					
BHW410	BHW495	BHW496	BHW585	BHW604	BHW276
Pine Oars 5 1/2ft	Pine Oars 6ft	Pine Oars 7ft	Pine Oars 8ft	Pine Oars 9ft	Rubber Oar Stops 41mm
					
BHW540	BHW306	BHW307	BHW281	BHW282	GCH034
Rubber Oar Stops 43mm	Rowlocks Open Type (Pair) 10mm	Rowlocks Ring Type (Pair) 12mm	Paddle Economy Alloy/Plastic 1.2m	Paddle Telescopic 1.07m	Boat Hook Telescopic Alloy 1.2m - 2.1m

MARINE SEALANTS

We stock a select range of FixTech and Sikaflex sealants for general purpose marine use. FixTech is used all around the globe from the searing heat of the deserts in the Middle East to the freezing cold of Antarctica.

					
FIX01	FIX02	FIX05	FIX03	FIX07	FIX08
Fix15 Multi-Purpose Sealant – White 290ml Cartridge	Fix15 Multi-Purpose Sealant – Black 290ml Cartridge	Fix15 Multi-Purpose Sealant – Grey 290ml Cartridge	Fix15 Multi-Purpose Sealant – White 600ml Sausage	MSP190 Structural White 290ml Cartridge	MSP190 Structural Black 290ml Cartridge
					
FIX09	PL1911	PL1909			
MSP190 Structural Black 600ml Sausage	Sikaflex 291 White Marine Sealant 310ml Sausage	Sikaflex 291 Black Marine Sealant 310ml Sausage			

TUBE CLIPS

UV resistant black nylon and available in a number of sizes, tube clips are very useful for securing round poles and handles of paddles, boat hooks and gaffs.



BHW397

Tube Clip Black
Nylon 15mm



BHW398

Tube Clip Black
Nylon 20mm



BHW399

Tube Clip Black
Nylon 25mm



BHW400

Tube Clip Black
Nylon 30mm



BHW401

Tube Clip Black
Nylon 35mm



BHW402

Tube Clip Black
Nylon 40mm



BHW403

Tube Clip Black
Nylon 45mm

CLEATS AND BOLLARDS

UV resistant black nylon, polished stainless steel and durable alloy cleats and bollards for securing your vessel.



BHW236

Nylon Cleat
Black
110mm



BHW495

Nylon Cleat
Black
145mm



BHW237

Nylon Cleat
Black
180mm



BHW238

Nylon Cleat
Black
210mm



BHW240

Stainless Steel
Slimline Cleat
100mm



BHW241

Stainless Steel
Slimline Cleat
155mm



BHW242

Stainless Steel
Slimline Cleat
250mm



BHW336

Nylon Jam Cleat
Small 3-6mm



BHW337

Nylon Jam Cleat
Large 6-12mm



BHW209

Alloy Dock Cleat
250mm



BHW007

Alloy Dock Cleat
350mm



BHW233

Cam Cleat Medium
3-12mm



BHW348

Bollard Alloy
80mm



BHW504

Bollard
Stainless Steel
90mm



BHW613

Bow Roller
Stainless Steel
220mm

ENGINE CONTROLS AND CABLES

Single and twin lever controls are available to suit your engine requirements. 30 and 40 series cables are ordered at the customers requested length.



BHW491

Engine Controls
NB Series
Twin lever

					
BHW882	BHW883	BHW841	BHW920	BHW478	BHW420
Engine Controls NB Series Single lever	Engine Controls KB Series Twin lever	Engine Controls Seastar Hydraulic	Engine Controls MT-3 Twin lever	Engine Control Cable 33C Custom Length	Engine Control Cable 40 Series Custom Length

TAPES AND MISCELLANEOUS ITEMS

	
PL4046	PL2278/9
Only sold per metre Croc Grip Tape 48mm	Only sold per metre Grip Tape (3M) 25 & 50mm

					
GCH150	GCH214	GCH212	GCH149	GCH213	GCH162
Exhaust Lagging 50mm x 30m	Denso Tape 50mm x 10m	Neoprene Hatch Seal 12mm x 3mm	Neoprene Hatch Seal 25mm x 6mm	Neoprene Hatch Seal 25mm x 20mm	Horse Float Rubber Deck Mat 1830mm x 1230mm x 8mm

					
GCH147	GCH500	BHW557	BHW884	GCH502	GCH503
Tube Tread Matting Per metre - Blue 900mm wide	Tube Tread Matting Per metre - Grey 900mm wide	Non Skid Tape Per Metre - Black 50mm wide	Sail Repair Kit	PVC Inflatable Boat Repair Kit	Hypalon PVC Inflatable Boat Repair Kit

					
PL2281 (per roll)	PL2275 (10 roll pack)	ELC091 (per roll)	PL2272 (per roll)	PL2271 (per roll)	PL2280 (per roll)
Thread Tape (10g) 12mm x 10m 52mm diameter	Electrical Tape (805g) 19mm x 20m (each) 75mm diameter	Electrical Tape (80g) 19mm x 20m 75mm diameter	Duct Tape Grey (240g) 25mm x 30m 125mm diameter	Duct Tape Black (450g) 48mm x 30m 105mm diameter	Black Scarpa Cloth Tape (270g) 25mm x 30m 155mm diameter

					
PL1626 (per roll)	SFT017 (per roll)	SFT016 (per roll)	PL1624 (per roll)	PL2270 (per roll)	PL2268
Also sold per metre (PL1628) Reflective Tape (440g) 50mm x 23m 120mm diameter	Also sold per metre (PL1630) YELLOW Reflective Tape (440g) 50mm x 23m 120mm diameter	RED Reflective Tape (440g) 50mm x 23m 120mm diameter	Also sold per metre (PL1625) HONEYCOMB Reflective Tape (440g) 50mm x 46m 120mm diameter	Denso Tape (930g) 75mm x 10m 145mm diameter	Only sold per metre Non-slip Tape 48mm

WINCHES AND TRAILER ROLLERS



BHW568













Ratchet Strap S/S
Medium Duty
50mm

					
BHW311	BHW312	BHW426	BHW576	BHW773	GCH029
Trailer Winch Economy 3:1 350kg	Trailer Winch Economy 4:1 635kg	Trailer Winch Stainless Steel 900kg	Trailer Winch Premium Atlantic 500kg	Trailer Winch Premium Atlantic 1500kg	Winch Handle Replacement Hex Head 7/8" 22mm
					
BHW310	BHW295	BHW296	BHW297	BHW298	BHW299
Winch Strap Replacement 6m x 50mm	Black Rubber Bow Roller 78mm	Black Rubber Dog Bone Roller 201mm	Black Rubber Keel Roller 113mm	Black Rubber Keel Roller 152mm	Black Rubber Keel Roller 201mm
					
BHW300	BHW301	BHW302	BHW303	BHW304	BHW305
Red Soft Poly Keel Roller 113mm	Red Soft Poly Keel Roller 148mm	Red Soft Poly Keel Roller 203mm	Red Soft Poly Self Centring Roller 153mm	Red Soft Poly Bow Roller 49mm	Wobble Roller Grey
					
BHW339	BHW340	BHW341	BHW342	BHW343	BHW344
Blue Hard Poly Keel Roller 3"	Blue Hard Poly Keel Roller 4"	Blue Hard Poly Keel Roller 6"	Blue Hard Poly Keel Roller 8"	Black Rubber Bow Wedge Large	Black Rubber Bow Wedge Small

HINGES AND LATCHES

					
BHW206	BHW262	BHW263	BHW264	BHW265	BHW266
Nylon Hinge White 60mm x 37mm	Nylon Hinge Black 60mm x 37mm	Nylon Butt Hinge Black 101mm x 59mm	Nylon Butt Hinge Black 64mm x 35mm	Nylon Butt Hinge Black 76mm x 41mm	Stainless Steel Butt Hinge 104mm x 75mm
					
BHW267	BHW269	BHW363	BHW232	BHW637	
Stainless Steel Butt Hinge 75mm x 48mm	Stainless Steel Strap Hinge 177mm x 43mm	Flush Polycarbonate Latch Black	Cam Action Hatch Fastener Stainless Steel 85mm	Cam Action Hatch Fastener Stainless Steel 145mm	

FISHING ROD HOLDERS

					
					BHW286
					Rod & Knife Storage Holder Vertical
					
BHW287	BHW288	BHW289	BHW290	BHW291	BHW292
Adjustable Nylon Rod Holder	Flush Angled Rod Holder Black	Flush Angled Rod Holder White	Flush Straight Rod Holder White	Rail Mount Rod Holder Stainless Steel	Side Mount Rod Holder Black
					
BHW293	BHW294	BHW395	BHW396	BHW775	BHW798
Side Mount Rod Holder White	Rod Storage Holder Horizontal	Flush Angled Rod Holder Stainless Steel	Flush Straight Rod Holder Stainless Steel	Rod Holder Extension Stainless Steel	Snapper Rack Rod Holder

CABLE TIES

We have a range of quality UV stabilised cable ties from 100mm total length up to 550mm.



PRODUCT CODE	LENGTH (MM)	WIDTH (MM)	QTY PER BAG
CT102B	100	2.5	100
GCH002	100	2.5	1,000
PL0279	140	3.6	1,000
CT143B	150	3.6	100
PL0281	160	2.5	1,000
CT160SB	160	4.8	100
PL0280	160	4.8	1,000
CT165B	165	2.5	100
GCH005	200	4.8	100

PRODUCT CODE	LENGTH (MM)	WIDTH (MM)	QTY PER BAG
CT194B	203	4.6	100
CT200B	203	7.6	100
CT280B	300	4.8	100
GCH006	300	4.8	100
GCH007	370	7.6	300
CT373B	380	7.6	100
CT370B	385	4.8	100
CT550B	550	7.6	100

INSPECTION PORTS



Inspection Port Clear	
PRODUCT CODE	SIZE (MM)
BHW385	150



Inspection Port White	
PRODUCT CODE	SIZE (MM)
BHW379	100
BHW381	125
BHW383	150



Inspection Port Black	
PRODUCT CODE	SIZE (MM)
BHW380	100
BHW382	125
BHW384	150

03 CHEMICALS & CLEANING PRODUCTS

- > Chemical Cleaners
- > Lubricants
- > Cleaning Accessories
- > Jotun Paint
- > West System Epoxy Resin

Seamaster carries a range of chemicals to keep your vessel in great condition and your gear clean.

Acid wash for decks, chlorinated agents for processing areas and citrus based cleaners and heavy-duty degreaser for the bilge. For marine paints and fibreglass products, Seamaster are authorised resellers of Jotun Marine paints. Brooms, brushes and scouring pads are also available.

- All products can be supplied with an MSDS on request.

CHEMICAL CLEANERS

CHM097	CHM095	CHM115	CHM122	CHM096	CHM117
Sierra Citrus 6000 Cleaner & Degreaser 5Ltr (AQIS Approved)	Sierra Citrus 6000 Cleaner & Degreaser 20Ltr (AQIS Approved)	Sierra Citrus Wash Cleaner & Degreaser 20Ltr	Sierra Acid Wash Cleaner 5Ltr	Sierra Acid Wash Cleaner 20Ltr	Sierra Deck Wash Acid 5Ltr
CHM116	CHM111	CHM112	CHM113	CHM114	PL0377
Sierra Deck Wash Acid 20Ltr	Sierra Detox Fibreglass Polish 1Ltr	Sierra Detox Fibreglass Polish 5Ltr	Sierra Night Glaze Finishing Polish 1Ltr	Sierra Night Glaze Finishing Polish 5Ltr	Septone Drifter Gelcoat Cleaner and Stain Remover 20L
PL0337	CHM037	PL0338	PL0364	PL2784	PL0365
Septone Drifter Gelcoat Cleaner and Stain Remover 5L	Septone Ali Brite Aluminium and Stainless Steel Cleaner 20L	Septone Ali Brite Aluminium and Stainless Steel Cleaner 5L	Bondall Ranex Rustbuster Rust Converter 500ml	Bondall Ranex Rustbuster Rust Converter 4L	Bondall Ranex Rustbuster Rust Converter 20L

LUBRICANTS



CHM087

Lanolin Grease 20L

PL0343	PL0350	CHM041	PL0379	PL0353	PL0383
Ballistol Cleaner and Lubricant 400ml Aerosol	Inox Lubricant 300g Aerosol	CRC Soft Seal Surface Film 300g Aerosol	Silicon Spray Series 500 Protectant 330g Aerosol	CRC Marine 66 Lubricant and Protectant 300g Aerosol	Vuplex Cleaner for Plastic and PVC 200g Aerosol
PL3787	PL4236	CHM069	CHM070	CHM071	CHM074
Rain-X Water Repellent 207ml Bottle	Rain-X Water Repellent 473ml Trigger Spray	Outboard 2 Stroke Oil 4L	Outboard 2 Stroke Oil 1L	Outboard Gear Oil 500ml	Grease Premium Marine Cartridge Gulf Western

CLEANING ACCESSORIES











CLN002







Bag of Rags - 10kg Mixed

BHW678	BHW679	BHW680	FSH1337	FSH1338	PL1903
Broom Handle 1300mm Aluminium to suit broom heads	Broom Head White Tank Hard 205mm	Broom Head White Hard 325mm	Ice Shovel 270mm Plastic Standard Handle	Ice Shovel Straight Handle Small Blade	Shovel Stainless Steel Head with Timber Handle
PL1907	PL1906	PL3748	PL0264	PL0263	PL0513
Shovel Vikan Ice Plastic with Drain Holes	Shovel Vikan Long Handle with 11" Blade	Shovel Fjord Plastic 14" Blade	Oates Light Sweep Soft Broom with Wooden Handle	Oates Deck Scrub Broom with Steel Handle	Oates Sure Grip Dustpan Set

JOTUN PAINT

					
CHM026	CHM027	CHM034	CHM035	CHM119	CHM040
Jotun Seavictor Antifouling 5 Litre Red	Jotun Seavictor Antifouling 5 Litre Black	Jotun Seasafe Ultra Antifouling 5 Litre Black	Jotun Seagardian Antifouling 5 Litre Black	Jotun Seagardian Antifouling 5 Litre Red	Jotun Seagardian Antifouling 10 Litre Black
					
CHM049	CHM121	CHM029			
Jotun Seagardian Antifouling 10 Litre Blue	Jotun Seagardian Antifouling 10 Litre Red	Jotun Vinyguard 88 Primer 5 litre			

WEST SYSTEM EPOXY RESIN

					
FBG0011	FBG0012	FBG0013	FBG0014	FBG0015	FBG0016
West System Epoxy Resin 4 Litre	West System Epoxy Resin 1 Litre	West System Epoxy Resin 500ml	West System Epoxy Hardener 800ml	West System Epoxy Hardener 200ml	West System Epoxy Hardener 100ml

04 FISHING GEAR

- > Cray pots and Accessories
- > Crimps
- > Crimping Tools
- > Crimping Dies
- > Gaffs, Spears, Tail Ropes and Landing Nets
- > Asano Equipment
- > Norwegian Bass Equipment
- > Hooks
- > Knives and Accessories
- > Underwater / Strobe Lights
- > Luminous Beads, Sleeves and Tubing
- > Lures
- > Monofilament and Braid
- > Other Monofilament Line Products
- > Netting
- > Rigging
- > Professional Squid Gear
- > Sinkers
- > Tuna Oil
- > Terminal Tackle
- > Swivels
- > Stainless Steel Wire











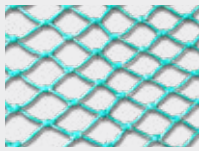
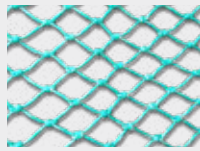





The Seamaster team are passionate lifelong fisherman. We carry only the best and most reliable fishing gear for commercial and recreational fishing.

Whether its dropping pots, longline or drop line, beach fishing, estuary or game fishing, right through to commercial trawling, if your income relies on your catch, Seamaster have high quality gear that won't let you down.

CRAY POTS AND ACCESSORIES

We stock a range of tea tree and steel cray pots and all the related equipment for you to fish efficiently, whether professionally or recreationally.

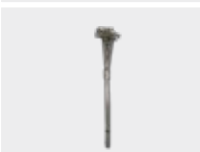
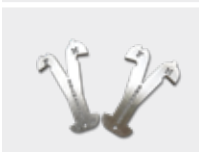
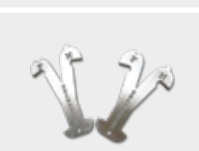
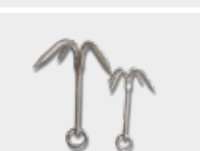
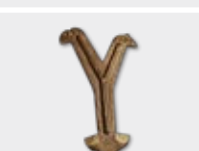
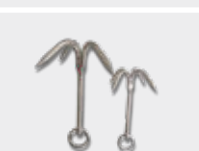
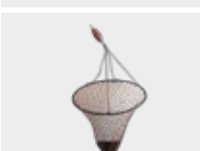
					
FSH0836	FSH1384	FSH1391	FSH1392	FSH1393	PL0410
Cane Cray Pot	Steel Cray Pot Galvanised	Steel Cray Pot 27kg	Steel Cray Pot 22kg	Steel Cray Pot 20kg	Cray Pot Recreational SA regulation
					
PL0413	PL0412	PL0416	PL0073	PL0074	AMAC007
Seal Exclusion device S/S fold down	Seal Exclusion device steel fixed	Escape gaps steel SA regulation per pair	Anode for Cray Pot CDA-0 380g	Anode for Cray Pot CDA-000 800g	Zinc Cray Pot Anode 1.07kg 3mm wire
					
FSH0046	FSH0047	FSH0113	PL0423	NET091	NET112
Cray Pot Neck Black Plastic	Cray Pot Neck Red Plastic	Cray Pot Toggle White Plastic	Cray Pot Toggle Wooden	Cray Pot Mesh PE Braided 4mm x 7.5 MD x 100m Bundle	Cray Pot Mesh PE Braided 4mm x 7.5MD Per Metre

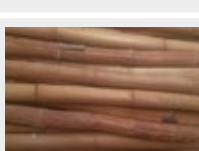
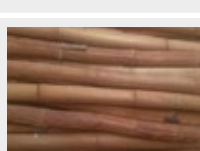
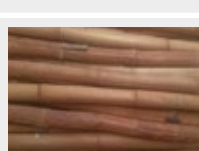
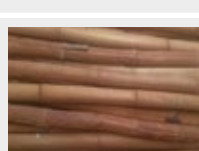
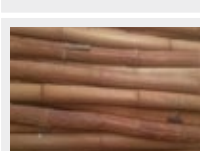
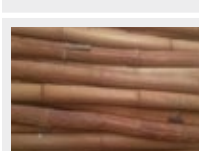
					
NET104	NET105	PL2513	PL0243	PL2763	FSH1058
Cray Pot Mesh Glow 75mm x 7.5MD x 1000 Meshes	Cray Pot Mesh Glow 75mm x 7.5MD Per Metre	Rope 40m complete with 1 x 8" white and 1 x 8" red	Rope 30m complete with 1 x 8" white and 1 x 8" red	Pot Making Cane Black Plastic 10mm x 200m	Cray Pot cane Black Plastic 250m roll
					
FSH2125	FSH0034	PL0213	PL2652	FSH2615	FSH2022
Bait Saver Black Plastic	Bait Basket HiFry	Bait Pot with screw top lid	Bait pouch plastic coated wire	Bait Basket Performance Tube 320mm x 120mm	Skewer S/S 316 6mm
					
FSH2423	FSH1309	PL2503	PL2505	PL2504	FSH2201
Skewer S/S 316 8mm	Wooden Skewer	Wire Toggles 2.5mm x 100pc	Wire Toggles 2.0mm x 100pc	Wire Toggles Welded T 2.5mm x 50pc	Seamaster Stainless Steel Crayfish Measure
					
FSH1408	GCH024	FSH2559	GCH023	FSH0045	FSH0983
Seamaster Stainless Steel Crayfish Measure M 110 mm / F 120mm (NW Tasmania)	Grapple S/S Small 420g	Bronze Cray Measure	Grapple S/S Large 930g	Cray Rings Complete	Cray Ring Net Brown Cotton
					
CANE8-10	CANE10-12	CANE12-15	CANE15-20	CANE20-25	FSH2481
Pot Making Cane Red Pahang 8-10mm 25kg Bundle	Pot Making Cane Red Pahang 10-12mm 25kg Bundle	Pot Making Cane Red Pahang 12-15mm 25kg Bundle	Pot Making Cane Red Pahang 15-20mm 25kg Bundle	Pot Making Cane Red Pahang 20-25mm 25kg Bundle	Cray Pot Cane 10-12mm 25kg

CRIMPS

We offer a wide range of copper and aluminium crimps to suit the full suite of monofilament and wire diameters. Copper crimps are best used in conjunction with wire, with aluminium best suited for swaging monofilament and fluorocarbon leader lines. Popular with both commercial and recreational fishers.



Alloy Single Long Crimp (18mm total length)		
PRODUCT CODE	SIZE	QUANTITY
FSH0108	1.5mm	1,000pc
FSH0024	1.7mm	1,000pc
PL0025	2.0mm	1,000pc
FSH0026	2.3mm	1,000pc
PL0028	2.6mm	1,000pc
FSH0027	2.8mm	500pc
PL0081	3.0mm	500pc
FSH0123	3.1mm	500pc
FSH0329	3.3mm	500pc
FSH0028	3.5mm	500pc
FSH0029	3.8mm	500pc
FSH0030	4.0mm	500pc
PL0036	4.2mm	500pc
PL0037	4.6mm	500pc
PL0038	4.8mm	500pc
PL0040	5.2mm	each

Mini Double Copper Crimps		
PRODUCT CODE	SIZE	QUANTITY
PL0003	0.8mm	1,000pc
FSH0039	1.0mm	1,000pc
FSH0040	1.3mm	1,000pc
FSH0041	1.6mm	1,000pc
FSH0042	1.9mm	1,000pc
FSH0037	2.2mm	1,000pc
FSH0633	2.4mm	1,000pc
FSH0038	2.6mm	1,000pc
PL0029	2.8mm	500pc
FSH1381	3.3mm	500pc

Alloy Single Mini Crimp (7mm total length)		
PRODUCT CODE	SIZE	QUANTITY
PL0001	0.7mm	1,000pc
FSH0031	0.8mm	1,000pc
FSH0032	1.0mm	1,000pc
PL0007	1.2mm	1,000pc
PL0008	1.3mm	1,000pc
FSH0033	1.5mm	1,000pc
PL0019	1.7mm	1,000pc
FSH0109	2.0mm	1,000pc

CRIMPING TOOLS

We have a range of hand crimping pliers and bench crimpers for swaging copper and aluminium crimps. Our hand crimping pliers suit swages from 0.7mm and upwards, and for industrial swaging we offer the Tai Show bench crimper and die sets to suit crimps from 1.3mm upwards.



GCH018

Crimping pliers Taiwanese hand held high grade ergonomic handle. 4 holes with side cutters

COLOURS	CRIMP SIZE
Red	0.7mm - 2.3mm



FSH0290

Crimping pliers hand held Korean. 4 holes with side cutters

COLOURS	CRIMP SIZE
Green	0.7mm - 2.3mm



FSH0289

Crimper Large Hand held. 5 holes

COLOURS	CRIMP SIZE
Black	1.0mm - 5.2mm



FSH0288

Crimper Bench Japanese Tai-Show

COLOURS	CRIMP SIZE
Grey	Variable





























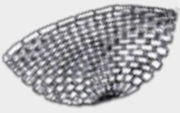

CRIMPING DIES

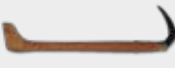

PRODUCT CODE	DESCRIPTION	LINE SIZE	TO SUIT CRIMP
FSH1289	# G Die	1.2mm - 1.4mm	1.3mm - 1.5mm
FSH1288	# F Die	1.5mm - 1.6mm	1.7mm
FSH1287	# E Die	1.8mm - 2.0mm	2.0mm - 2.2mm
FSH1286	# D Die	2.2mm	2.3mm
FSH1284	# BC Die	2.2mm - 2.8mm	2.6mm - 3.0mm
FSH1283	# B Die	3.0mm	3.2mm
FSH1282	# A Die	3.3mm - 4.0mm	3.5mm - 4.2mm
PL0491	# A1 Die	4.0mm - 5.0mm	4.5mm - 5.5mm
PL0497	A0 # LL	5.0mm - 5.5mm	5.5mm - 6.0mm

GAFFS, SPEARS, TAIL ROPES AND LANDING NETS

Select from a wide range of combinations to suit your needs. Structural grade anodised aluminium handle. Either stainless steel or aluminium hooks. Stainless steel hardware. Single or 2-piece. These products can be made to order to your specific requirements.

					
FSH0801	FSH0802	FSH0803	FSH0805	FSH0806	FSH1155
Light Fixed Gaff 65mm x 6mm x 850mm	Light Fixed Gaff 85mm x 8mm x 1000mm	Heavy Duty Fixed Gaff 150mm x 13mm x 1600mm	Flying Gaff 150mm x 13mm x 1700mm	Flying Gaff 200mm x 16mm x 1700mm	Flying Gaff 175mm x 16mm x 1700mm
					
FSH2311	FSH2446	FSH2016	FSH2180	FSH1220	FSH2471
Flying Gaff Hook'em 16mm x 250mm HD	Gaff Telescopic 2-4m 8 x 85mm Hook	Heavy Duty Fixed Handle Gaff Made to Order	Gaff-Mann Flying Gaff/Spear/ Fixed Gaff Combo	Gaff-Mann Tail Rope with Pole	Gaff Hook Only S/S 6mm
					
FSH2472	FSH0276	FSH0280	FSH0810	FSH0811	FSH2417
Gaff Hook Only S/S 8mm	Gaff Hook 1/0	Gaff Hook 5/0	Hook'em Standard Rubber Landing Net	Hook'em Large Rubber Landing Net	Hook'em XLarge Heavy Duty Rubber Net
					
FSH2350	FSH0501	FSH0502	PL0841	PL0843	PL0845
Rubber Landing Net Replacement Only	Berkley Rubber 4ft Net	Berkley Rubber Snapper Net	Gaff 4' (1200mm) Alloy with Grip	Gaff 2ft Deluxe Aluminium	Gaff 240mm Wooden Handle
					
PL0846	PL0848	PL0849	PL0850	PL0852	PL0853
Gaff 360mm Wooden Handle	Gaff 6' Heavy Duty Alloy with Grip	Gaff 600mm Wooden Handle	Gaff 900mm Wooden Handle	Gaff Boat Hook Alloy/Plastic 1.5m	Gaff Boat Hook Telescopic 1.2-2.1m

					
PL0854	PL4667	PL4668	PL4669	PL0225	PL2017
Gaff Boning Hooks Dexter Orange Handle	Gaff Poles Tasmanian Oak 35mm x 2.4m	Gaff Poles Tasmanian Oak 35mm x 3.0m	Gaff Poles Tasmanian Oak 35mm x 3.6m	Boat Hook Head Only 30mm Black	Spear 6'6" 2 piece Alloy Mirage
					
PL0922	PL0921	PL0478	PL1498	PL4121	PL4122
Harpoon Head 90mm	Harpoon Head 130mm	Dab Net Wood Handle	Dab Net 36" Gar Replacement Netting	Landing Net 570 x 670 Nylon Netting	Landing Net 480 x 465 Nylon Netting 1m Handle
					
PL0243	PL4085	PL4033	PL4223	FHS0398	FSH0399
Landing Net Rubber Medium (Wilson) 48 x 20cm Head 80cm Handle	Landing Net Rubber XLRG (Wilson) 40 x 70cm Head 130cm Retractable Handle	Bait Scoop Net 200mm Handle	Replacement Rubber Net (Suitable for Wilson Medium Net)	Spear Single Prong	Spear 3 Prong





ASANO EQUIPMENT

We import Japanese designed and made Asano stainless steel equipment and components for commercial fishing and aquaculture. Designed and constantly refined to withstand the harsh marine environment, Asano equipment is made from high grade stainless steel to offer a balance between strength and longevity.

					
PL3996	PL3591	PL3703	PL4104	PL4210	PL4209
Daruma Block 75mm Type PB with Bearing SWL 0.7t UNIT WEIGHT: 1.3kg	AK Pulley Block 50mm Type PB with Bearing SWL 0.4t UNIT WEIGHT: 0.5kg	AK Pulley Block 75mm Type PB with Bearing SWL 0.6t UNIT WEIGHT: 1.3kg	AK Pulley Block 100mm Type PB with Bearing SWL 1.0t UNIT WEIGHT: 2.5kg	AK Double Pulley Block 75mm Type PB with Bearing SWL 0.6t UNIT WEIGHT: 2.3kg	AK Double Pulley Block 100mm Type PB with Bearing SWL 1.0t UNIT WEIGHT: 4.3kg
					
PL3916	PL4212	PL4190	PL4211	PL4266	
Hanging Roller 80mm Type PB with Bearing SWL 1.0t UNIT WEIGHT: 2.8kg	AK Pulley Block 100mm Type PB-S with Nylon Sheave SWL 1.0t UNIT WEIGHT: 1.6kg	Auto Shackle Type 3 SWL 0.8t UNIT WEIGHT: 0.4kg	Auto Shackle Type 2 SWL 2.0t UNIT WEIGHT: 1.2kg	Auto Shackle Type 2S SWL 2.8t UNIT WEIGHT: 1.3kg	

NORWEGIAN BOSS EQUIPMENT

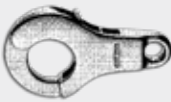
We import Norwegian Boss purse seine equipment and accessories. Made from the highest-grade acid proof stainless steel, Boss manufacture world renowned commercial fishing equipment for harsh environments.

					
PL2816	PL2815	PL0252	PL0253	PL3953	PL4188
Boss 90 SR Purse Ring SWL 3.5t UNIT WEIGHT: 7.80kg	Boss Safety 9 SR Purse Ring SWL 2.5t UNIT WEIGHT: 7.80kg	Boss DL 18 S Split Link SWL 0.2t UNIT WEIGHT: 180g	Boss DL 19 S Split Link SWL 0.4t UNIT WEIGHT: 290g	Boss DL 26 Sister Clip SWL 3.0t UNIT WEIGHT: 1.7kg	Boss GH 6 S G-Hook SWL 6.0t UNIT WEIGHT: 2.90kg
					
PL4189	PL2800	PL4258	PL3842	PL3504	PL2511
Boss L 6 S Split Link SWL 6.0t UNIT WEIGHT: 1.60kg	Boss L 3 S Split Link SWL 3.0t UNIT WEIGHT: 0.80kg	Boss TOW 15 S Release Hook Break Load 48t UNIT WEIGHT: 15.80kg	Boss RH 2T Release Hook Break Load 10t UNIT WEIGHT: 1.60kg	Boss BK 12 Brailing Net Lock SWL 0.9t UNIT WEIGHT: 8.30kg	Boss SL 12 S Shackle SWL 6.0t UNIT WEIGHT: 1.50kg
					
PL2510	PL2509				
Orange Winter Freezer Boot SIZE: 7-13	Boss SW 30 S Swivel SWL 3.0t UNIT WEIGHT: 0.90kg				

HOOKS

Long Shank

Mustad brand, long shank hook, popular in the longline shark fishery.

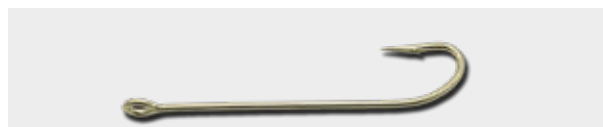

PRODUCT CODE	DESCRIPTION	SIZE	PACKET QUANTITY	BOX QUANTITY
FSH2134	Mustad Long Shank 8318D 130mm x 30mm	10/0 (3.2mm wire)	1	500

Sports Circle Hooks

Circle hooks are a popular hook pattern for commercial longlining and drop lining for a range of species. At Seamaster we offer a range of quality stainless steel offset circle hooks. The Sports Circle 39960 is a good all-round pattern and popular for longlining demersal shark and finfish. The forged offset is a popular heavy duty hook for commercial and recreational fishing for larger sharks and game fish. The Sports Circle hook with crane swivel is a popular hook for drop lining in deeper water.

We also carry a large range of light tackle sport fishing hooks from the most popular brands, Gamakatsu, Owner and Mustad.



Circle Hook SS offset 39960 with #3 swivel			
PRODUCT CODE	SIZE	QUANTITY	
FSH0013	12/0 (3.0mm wire)	each	
FSH0015	13/0 (3.2mm wire)	each	
FSH0314	14/0 (3.4mm wire)	each	



Circle Hook Forged SS offset			
PRODUCT CODE	SIZE	QUANTITY	
PL0982	14/0 (4.4mm wire)	each	
PL0979	16/0 (4.8mm wire)	each	
FSH0018	18/0 (5.0mm wire)	each	



PRODUCT CODE	DESCRIPTION	SIZE	QUANTITY
PL2968	Circle Hook SS offset with ring	14/0 (4.4mm wire)	each
PL0983	Circle Hook SS Maruto Hook	14/0 (5.0mm wire)	each



Sports Circle Hook SS offset 39960			
PRODUCT CODE	SIZE	QUANTITY	
FSH0007	10/0 (2.6mm wire)	each	
FSH0010	11/0 (2.8mm wire)	each	
FSH0012	12/0 (3.0mm wire)	each	
FSH0014	13/0 (3.2mm wire)	each	
FSH0016	14/0 (3.4mm wire)	each	
FSH0017	16/0 (4.0mm wire)	each	

E-Z Baiter Hooks

E-Z Baiter hooks offer the advantages of a circle hook but with a slightly longer shank. Commonly used for autoline and longlining.



E-Z Baiter Nickel Hooks			
PRODUCT CODE	SIZE	PACKET QUANTITY	BOX QUANTITY
FSH0281	11/0	5	100
FSH0282	12/0	5	100
FSH0283	13/0	5	100
FSH0284	14/0	5	100

Straight J Hooks

Our range of Straight Shank J Hooks are popular with commercial and recreational fishers. The Sports Hook Type 7691 is a stainless steel non-offset hook and is widely used in game fishing, commercial fishing and in lure manufacturing. The Swordfish 7732 is a heavier gauge stainless steel non-offset hook and is a good option for heavy tackle fishing.



Sports J Hook SS non-offset type 7691

PRODUCT CODE	SIZE	QUANTITY
FSH0019	5/0 (2.4mm wire)	each
FSH0020	6/0 (2.6mm wire)	each
FSH0021	7/0 (2.8mm wire)	each
FSH0022	8/0 (3.0mm wire)	each
FSH0023	9/0 (3.6mm wire)	each
FSH0008	10/0 (3.8mm wire)	each
FSH0011	11/0 (4.8mm wire)	each
PL1049	12/0 (5.0mm wire)	each



Swordfish Hook SS non-offset type 7732

PRODUCT CODE	SIZE	QUANTITY
PL1060	10/0 (4.8mm wire)	each
PL1061	11/0 (5.0mm wire)	each
FSH2207	12/0 (5.2mm wire)	each

Octopus Hooks

Quality Octopus beak hooks, for recreational and small scale fish.



PRODUCT CODE	SIZE	PACKET QUANTITY	BULK QUANTITY
FSH0972	#2	40	1000
FSH0971	#4	20	1000
FSH0376	1/0	25	1000
FSH0377	2/0	40	1000
FSH0378	3/0	35	1000
FSH0379	4/0	30	1000
FSH0380	5/0	20	1000
FSH0381	6/0	20	1000
FSH0382	7/0	15	1000
FSH0383	8/0	15	1000
FSH0384	10/0	8	1000

KNIVES AND ACCESSORIES

Select from a comprehensive range of knives. Made with quality marine grade stainless steel and high carbon steel blades, and designed for a range of applications, we are sure to have a knife to suit your requirements.

Victory

					
FSH2071	FSH2147	FSH2189	FSH1331	FSH1370	FSH1371
Victory Straight Filleting 20cm	Victory Wide Filleting 22cm	Victory Curved Filleting 25cm	Victory Serrated Dive Knife Blunt 17cm	Victory Fish Splitter 30cm	Victory Butchers Knife 20cm
					
PL2592	PL1288	PL1290	PL1291	FSH2599	
Victory 100mm Blade 2 604 10	Victory Serrated Deckies Knife 9cm 3 343 10	Victory Serrated Dive Knife Blunt 11cm 2 342 10	Victory Serrated Dive Knife Blunt 16cm	Victory Serrated Dive Knife Pointed 17cm	







Giesser

					
FSH2621	FSH2622	FSH2239	FSH2240	FSH2762	FSH2763
Giesser Butcher Knife 21cm	Giesser Fish Slicer 18cm	Giesser Fish Slicer 21cm	Giesser Boning Knife 15cm	Giesser Fish Slicer Curved 21cm	Giesser Skinning Knife 18cm

Frosts Mora

						
				FSH0054	FSH0056	FSH0057
				Morakniv Companion Blue Outdoor Sports	Mora Frost Fillet Knife 6.25"	Mora Frost Fillet Knife 128-0917
						
FSH0058	FSH0059	FSH0060	FSH0061	FSH0162	FSH0163	
Mora Frost Poultry 4"	Mora Frost Fillet Narrow 7"	Mora Frost Boning Narrow 5" Curved	Mora Frost Boning 5" Curved Blue	Mora Frost Bait 9106UG (4591)	Mora Frost 153mm Straight Wide Boning-Stiff	
						
FSH0164	FSH0165	FSH0166	FSH0167	FSH0349	FSH2314	
Mora Frost Filleting 180mm Semi Flex 129-3805	Mora Frost Skinning 3305PG S/S High Carbon (4474)	Mora Frost Butcher 205mm Stiff 1-0147	Mora Frost Butcher 6" (3968)	Mora Companion F Rescue (Round Safety Tip)	Mora Companion F Multi Colour	
						
FSH2551	FSH1216	FSH1217	FSH1295	PL1236	PL1231	
Mora Allrounder Basic	Mora Frost 8" Curved 7215PG	Mora Frost 305mm Curved Steak 7305UG	Mora Frost Gutting Knife with Spoon	Mora Frost Spoon Only	Mora Frost 6" Fillet 9160PG	
						
PL1232	PL3956	PL1245	PL1233	PL1230	PL1244	
Mora Frost 6" Blue Handle Bait Knife 1030SP	Mora Frost 8" Semi Flex 8197UG	Mora Frost 8" Boning 9210P	Mora Frost 5" Curved LS5-G1	Mora Frost 6" Curved CB6F-E	Mora Frost 6" Curved 7158UG	
						
PL1256	PL1229	PL2512	PL1238	PL3496	PL1255	
Mora Frost 5" Boning 7126PG	Mora Frost 5" Cutting 4130PG	Mora Frost 7" Chef's 4171PG	Mora Frost 10.5" Chef's 4261UG	Mora Frost 10" Butcher 7253UG	Mora Frost 6.25" Curved 7162UG	

SICUT

					
FSH3017	FSH3016	FSH3015	FSH3020	FSH3019	FSH3018
SICUT 8" Curved Fillet Knife White Glow Handle	SICUT 7" Fillet Knife White Glow Handle	SICUT 6" Curved Boning Knife White Glow Handle	SICUT Anglers Diamond Package White Handle	SICUT Diamond Fisherman Package White Handle	SICUT All Purpose Knife Package White Handle







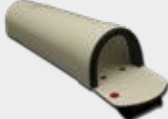

Standard Imported Range

					
FSH0086	FSH0261	FSH0087	FSH0258	FSH0259	FSH0262
K1 350mm Plastic Handle	K2 350mm Plastic Handle	K3 455mm Plastic Handle	Kaibo #A123 180mm (double grind)	Sashimi #A134 270mm	Fish Cutting #C312 220mm
					
PL1260	PL1279	PL1280	PL1217	PL3459	PL1259
Magiri Knife 135mm with Leather Sheath	Sashimi Knife 240mm	Bleed Knife B231 LOA 125mm	Stomach Drop Blood Knife B211	S/S Fish Cutting Knife 130mm	Kaibo Carbon Fish Cutting Knife 115mm
					
PL1209	FSH0050				
Deba 140mm (single grind)	Deba #A113 180mm (single grind)				

Oyster Knives, Dive and Abalone Knives, Scalers, Cleavers and Fish Despatch

					
PL2899	FSH0077	FSH0085	FSH0976	PL3671	FSH1294
Oyster Knife Dexter Plastic Handle White	Oyster Plastic Handle White	Oyster Wooden Handle	Abalone Dive Knife Samoa	Abalone Knife 19cm	Heavy Duty Cleaver
					
FSH2009	FSH2194	PL1216	PL1211	FSH0989	
Large Plastic Fish Scaler	T-Handle Fish Piercer	Dive Knife Pointed End Samoa	Dexter 12" Scalloped Utility	Iki Fish Spike SS 170mm Long Offset	

Storage

					
FSH2072	FHS2073	FSH2074	FSH2075	FSH2076	FSH2077
Sheath Victory without Loop	Buckets White	Buckets Black	Wrap Tramontina 4 Pocket	Magnetic Strip Tramontina 45cm	Magnetic Strip Tramontina 30cm
					
FSH3011	FSH3012	FSH3013			
8pce Full Canvas Wrap	10pce Full Canvas Wrap	12pce Full Canvas Wrap			

Victorinox







					
FSH0095	FSH0096	FSH0097	FSH0098	FSH0099	FSH0100
Victorinox 5.0501 Shaping Curved Blade Red 6cm	Victorinox 5.0503 Shaping Curved Blade Black 6cm	Victorinox 5.0601 Pairing Pointed 8cm	Victorinox 5.0603 Pairing Pointed 8cm	Victorinox 5.0631 Pairing Wavy Edge 8cm	Victorinox 5.0633 Pairing Wavy Edge 8cm
					
FSH0101	FSH0102	FSH0103	FSH0104	FSH0105	FSH0106
Victorinox 5.0701 Pairing Pointed 10cm	Victorinox 5.0703 Pairing Pointed 10cm	Victorinox 5.0731 Pairing Wavy Edge 10cm	Victorinox 5.0733 Pairing Wavy Edge 10cm	Victorinox 5.0831 Pairing Wavy Edge 11cm	Victorinox 5.0833 Pairing Wavy Edge 11cm
					
FSH0107	PL4077				
Victorinox 5.4623.30 Salmon Fluted Edge 30cm	Victorinox Swibo Butchers 14cm 5.8421.14				

Scissors and Cutters



NET030

HSGM Hot Knife
Made in Germany

					
NET031	NET107	GCH008	PL1467	FSH0292	GCH012
Hot Knife Blade Standard	Hot Knife Blade 45mm F-2	Blue Handled S/S Scissors	Yellow Handled S/S Japanese Scissors	Wire Cutter Small	Rope and Mono Cutters #S13023

Scales



FSH0494

Berkley
Digital Scales
23kg capacity

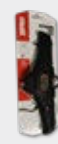

FSH2954

Rapala
Digital Scales
23kg capacity

Sharpeners



GCH016

Sharpening
Whetstone
8" x 2" x 1" - FINE



PL1897

Sharpening
Whetstone
8" x 2" x 1"
Coarse / Medium



GCH015

Sharpening
Whetstone
8" x 3" x 2" - FINE



PL1899

Sharpening
Whetstone
8" x 3" x 2"
Coarse / Medium



FSH2103

Diamond Steel
12"



PL1253

Sharpening Steel
10"
Frost Medium



PL1254

Sharpening Steel
Frost
Yellow Handle

Nirey Electric Knife Sharpeners



PL3047

Nirey
Replacement
Drums



PL1219

Nirey
Electric Sharpener
Recreational KE198



PL1220

Nirey Electric
Sharpener
Professional KE3000



PL3580

Nirey Electric
Sharpener H/D
Commercial KE280



PL1218

Nirey
Replacement Belts
Fine, Med, Coarse



FSH2784

Ceramic Sharpener
10" Fine



FSH2785

Ceramic Sharpener
12" Fine



FSH2781

Honing Steel 10"
Regular



FSH2783

Honing Steel 12"
Regular



FSH2786

Polishing Steel 12"
Superfine



FSH2780

Diamond Steel 12"



FSH2775

Manual Knife
Sharpener Two
Stage



FSH2776

Manual Knife
Sharpener Multi
Angled

UNDERWATER / STROBE LIGHTS

Select from a wide range of combinations to suit your needs. Structural grade anodised aluminium handle. Either stainless steel or aluminium hooks. Stainless steel hardware. Single or 2-piece. These products can be made to order to your specific requirements.

					
LHT003 Model: DF66 Depth: 700m Battery: 2 x AA 130x35mm Attachment: S/S Clip	LHT005 Model: DF66 Depth: 700m Battery: 2 x AA 130x35mm Attachment: S/S Clip	LHT006 Model: DF66 Depth: 700m Battery: 2 x AA 130x35mm Attachment: S/S Clip	LHT008 Model: DF66 Depth: 700m Battery: 2 x AA 130x35mm Attachment: S/S Clip	LHT009 Model: DF66 Depth: 700m Battery: 2 x AA 130x35mm Attachment: S/S Clip	PL0546 Model: DF66 Depth: 700m Battery: 2 x AA 130x35mm Attachment: S/S Clip
					
LHT057 Model: Diamond Depth: 1000m Battery: Sealed 25x30mm Attachment: Loop	LHT089 Model: Diamond Depth: 1000m Battery: Sealed 25x30mm Attachment: Loop	LHT090 Model: Diamond Depth: 1000m Battery: Sealed 25x30mm Attachment: Loop	LHT022 Model: Chemical Light Stick 100x10mm Attachment: Clip	LHT058 Model: Chemical Light Stick 100x10mm Attachment: Loop Tie	SFT025 Model: Beacon Strobe KS-68 Battery: 2 x D 200x40mm Attachment: Threaded
					
PL2061 Model: Beacon Strobe KS-68 Battery: 2 x D 200x40mm Attachment: Threaded	SFT026 Model: Beacon Strobe SY-61A Battery: 2 x D 280x50mm Attachment: Threaded	LHT011 Model: Flounder Light Cree LED Battery: 3 x C	FSH1072 Model: Flounder Light Neptune Underwater Halogen 50 Watt Battery: 12V 750mm handle	FSH1151 Model: Flounder Light Neptune Underwater Halogen 100 Watt Battery: 12V 750mm handle	PL2057 Model: Strobe SK 4000 auto on/off Battery: D x 1 130x52mm
					
PL2063 Model: Strobe CH2000B(R) on/off switch Battery: 4 x AA 132x48mm	PL2064 Model: Strobe CH2000B(W) on/off switch Battery: 4 x AA 132x48mm	PL2065 Model: Strobe CH2000B(Y) on/off switch Battery: 4 x AA 132x48mm	PL2062 Model: Strobe CH2000B(G) on/off switch Battery: 4 x AA 132x48mm	LHT163 LED Light Bullet Blue 1000m 950x20mm Battery: Sealed Attachment: Loop	LHT162 LED Light Bullet Green 1000m 950x20mm Battery: Sealed Attachment: Loop
					
LHT161 LED Light Bullet White 1000m 950x20mm Battery: Sealed Attachment: Loop	LHT160 LED Light Bullet Yellow 1000m 950x20mm Battery: Sealed Attachment: Loop	LHT159 LED Light Bullet Disco 1000m 950x20mm Battery: Sealed Attachment: Loop			

LUMINOUS BEADS, SLEEVES & TUBING

We offer a range of luminous accessories for commercial and recreational rigging, from luminous light sleeves to beads and tubing. Luminous accessories offer a light attractant as well as protection against chaffing on leader lines and branch lines. Luminous light sleeves and tubing also assist in neat presentation of baits and lures. Luminous octopus and squid skirts add an extra attractant to your rig.



PL3048

Branchline Tube
Grey/White 1.8mm
100m

FSH0044	PL2970	PL0293	PL0208	PL3432	PL3433
Luminous light sleeves 5cm 250pc	Luminous light sleeves 10cm 250pc	Luminous beads 18x10mm 500pc	Luminous beads 11x8mm each	Luminous Tube Pink 2.3mm 200mm	Luminous Tube Clear 2.3mm 200mm
FSH2023	FSH3430	FSH0071	FSH2014	FSH2133	FSH2015
Luminous Tube Green 1.8mm 200mm	Luminous Tube Pink 2.1mm 200mm	Luminous Tube Pink 2.3mm 200mm	Luminous Octopus Skirt 12" 300mm	Luminous Squid Lure Green 90mm	Luminous Squid Lure Pink 90mm

LURES

Rapala

We stock a wide range of Rapala lures, from small models suited to trout and bream, all the way through to the X-Rap Magnum's that dive to depths of up to 40ft. They are available in a massive range of sizes and colours.



Atomic

Atomic lures are a high quality and durable hard bodied lure that is available in a range of sizes and colours to suit trout and bream through to kingfish and tuna. Popular with sportfishermen looking for that edge.



Halco Laser Pro DD

The latest in lure technology incorporating strength, durability and fish catching ability. The outer body has extra secure hook anchoring and towing points that are built in as an integral part of the lure body. Halco's Bulletproof bib securing system provides added strength and ensures faultless swimming performance at high and low speeds. Halco Laser Pro lures are precision built for maximum fish catching ability.

DESCRIPTION	DIVE DEPTH	TROLLING SPEED	APPLICATION	BUOYANCY
Laser Pro 160DD	2m+	3-11 knots	Trolling/Casting	Floating
Laser Pro 190DD	2m+	3-11 knots	Trolling/Casting	Floating
Laser Pro 120DD	2.5m+	1-7 knots	Trolling/Casting	Floating
Laser Pro 140DD	2.5m+	3-11 knots	Casting/Trolling	Floating
Laser Pro 190XXD	6m+	3-11 knots	Trolling/Casting	Floating



Halco Max Pro DD

This cutting edge bibless minnow can do the lot, be it jigging, casting or trolling. Max has a highly streamlined design, that gives the lure unbeatable casting ability, while allowing high trolling speeds with minimal resistance. The slender tail section is designed for maximum hook exposure on the strike. Max represents the lure of the future. It goes without saying that Max incorporates Halco's legendary toughness and durability that keep Halco ahead of the rest.

DESCRIPTION	DIVE DEPTH	TROLLING SPEED	APPLICATION	BUOYANCY
Max 110	2m	2-15 knots	Jigging/Casting/Trolling	Rapid Sinking
Max 130	2m	2-15 knots	Jigging/Casting/Trolling	Rapid Sinking
Max 190	2m	2-15 knots	Jigging/Casting/Trolling	Rapid Sinking
Max 220	2m	2-15 knots	Jigging/Casting/Trolling	Rapid Sinking



Pakula Lures

Pakula Lures are possibly the most recognisable and successful gamefishing lures in the world. Peter Pakula has been at the forefront of lure design for decades and continues to produce new and innovative products. From lures to teasers, we stock a range of Pakula tackle to catch that fish of a lifetime.



Meridian Lures

A lure for every fishing condition. We stock a range of head shapes, sizes and colours of Meridian Lures, which are proven tuna catchers. Meridian Lures are Tasmanian owned and made and hand crafted individually, with unique custom skirts.



Soft Plastic Lures

The range of soft plastic lures on the market is enormous. Stocking the popular brands, Seamaster is sure to have a style to suit the species of fish you are chasing.

Shimano Squidgies

Designed by Australia's top fishermen for our conditions, Squidgies are a household name in soft plastic lures.



Berkley Gulp

The Gulp range of soft plastics come packaged in their uniquely formulated scent that quite often out fishes real bait.



Berkley Powerbait

Copied by many other brands, the Powerbait range of soft plastics has a lure to suit all species of fish.



MONOFILAMENT AND BRAID

We offer a range of bulk monofilament lines from 1.0mm up to 4.0mm in diameter. Seamaster brand and made in Taiwan, this range of mono line is popular with commercial fishermen and recreational fishers alike. **Ask us about our range of aluminium swages to suit.**

Features

- > Offered in clear, blue and red
- > Made as medium supple mono line
- > Supplied in hanks



PRODUCT CODE	COLOUR	DIAMETER	BREAK STRENGTH	HANK SIZE / LENGTH
FSH0634	Clear / Natural	1.0mm	100lb	1000m
FSH0078	Clear / Natural	1.2mm	130lb	1000m
FSH0635	Clear / Natural	1.4mm	200lb	1000m
FSH0079	Clear / Natural	1.6mm	250lb	1000m
FSH0120	Clear / Natural	1.8mm	325lb	1000m
PL2965	Blue / Grey	1.8mm	325lb	1000m
FSH0080	Clear / Natural	2.0mm	450lb	1000m
PL3042	Dark Blue	2.0mm	450lb	1000m
PL3043	Deep Red	2.0mm	450lb	1000m
FSH0081	Clear / Natural	2.2mm	520lb	500m
FSH0082	Clear / Natural	2.8mm	550lb	500m
FSH0306	Clear / White	3.0mm	913lb	500m
FSH0639	Clear / Natural	3.0mm	600lb	200m
PL3470	Clear / Natural	3.5mm	720lb	1000m
FSH0307	Clear / White	3.5mm		250m
FSH0308	Clear / White	4.0mm	1300lb	250m

OTHER MONOFILAMENT LINE PRODUCTS

Platypus Stealth Leader

Fluorocarbon monofilament leader is invisible under water to fool finicky fish.



PRODUCT CODE	BREAK STRENGTH
FSH2456	6lb
FSH0589	8lb
FSH2457	10lb
FSH0590	15lb
FSH0591	20lb
FSH2526	30lb

Seamaster Braid

Ultra-smooth 8 strand Japanese Dyneema braided fishing line.



PRODUCT CODE	DIAMETER	BREAK STRENGTH	LENGTH
FSH1262	0.14mm Yellow	10lb	150m
FSH1251	0.18mm Yellow	15lb	150m
FSH0323	0.20mm Yellow	20lb	150m
FSH0324	0.26mm Yellow	30lb	300m
FSH0325	0.36mm Yellow	50lb	300m
FSH1263	0.36mm Multicolour	50lb	500m
FSH0326	0.48mm Multicolour	80lb	1000m
FSH2138	0.48mm Yellow	80lb	3000m
FSH0328	0.61mm Multicolour	120lb	1000m

Jinkai Leader

High quality Japanese leader.



PRODUCT CODE	DIAMETER	BREAK STRENGTH	LENGTH
FSH1348	0.40mm	40lb	50m
FSH1349	0.57mm	60lb	50m
FSH1350	0.77mm	80lb	50m
FSH2541	0.87mm	100lb	50m
FSH2542	0.97mm	120lb	50m
FSH2543	1.04mm	150lb	50m
FSH1351	1.2mm	200lb	50m
FSH1352	1.8mm	400lb	50m

Platypus Pretest Fluoro

Premium grade sportfishing and game line. Popular with top game fishermen.



PRODUCT CODE	BREAK STRENGTH
FSH2166	10kg
FSH0586	15kg
FSH0587	24kg
FSH0588	37kg

Halco Wind On Leader

Extra tough wind-on leaders.



PRODUCT CODE	BREAK STRENGTH
PL1349	60lb
PL1350	80lb
FSH1333	100lb
FSH1334	150lb
FSH2176	400lb

Lindgren-Pitman Mono Spool

Quality monofilament sourced from Hawaii.



PRODUCT CODE	DIAMETER	BREAK STRENGTH	LENGTH
FSH2448	1.4mm Dark Blue	200lb	6728m
FSH2447	1.4mm Light Blue	200lb	6728m
FSH1382	3.5mm		2148m
FSH1383	4.0mm		1640m

Mono Line with 100 Sleeves



PRODUCT CODE	DIAMETER	BREAK STRENGTH	LENGTH
FSH0294	1.6mm	319lb	250m
FSH0295	1.8mm	396lb	250m
FSH0296	2.0mm	473lb	250m
FSH0297	2.2mm	517lb	250m
FSH1281	3.6mm		5000m

RODS AND REELS

Seamaster can supply all the major brands of rods and reels. Our expert staff can set you up to tackle that trophy of a lifetime.

Alvey

Australian made Alvey reels are a household name and make quality deepsea and surf reels.



FSH2756

Alvey Reef Queen

Shimano

World renowned for quality tackle.



FSH2584

Shimano Electric Rod and Reel

NETTING

Monofilament Fishing Nets



PRODUCT CODE	NET BUNT SIZE	COLOUR
NET094	0.90mm x 6 1/4" x 20md x 1000m	Dark Blue
NET095	0.90mm x 6 1/2" x 20md x 1000m	Dark Blue
NET096	0.52mm x 4 3/4" x 33md x 100m	Natural White
NET097	0.52mm x 5 1/4" X 50md x 200m	Natural White
NET098	0.60mm x 5 1/2" x 25md x 200m	Red
NET099	0.52mm x 5" x 100md x 100m	Natural White
NET100	Multi 0.20mm*7 x 5 1/2" x 25md x 200m	Red
NET101	0.90mm x 6 1/2" x 20md x 1000m	Dark Blue
NET102	0.52mm x 4 3/4" x 50md x 100m	Natural White
NET113	0.90mm x 6" x 20md x 1000m	Dark Blue

RIGGING



Seamaster Swordfish Rig

FSH2135PKTBOM

Designed and made by Seamaster using 5 metres of 400lbs mono with a 18/0 circle hook and a lumo octopus skirt.

HOOK SIZE: 18/0 Circle
NO. OF HOOKS: 1



Jig-Ems

FSH2242

COLOUR:
Various
LENGTH:
9cm



Jig-Ems

FSH2243

COLOUR:
Various
LENGTH:
13cm



Seamaster Stripey Rig

FSH0795PKTBOM

Designed and made by Seamaster using 400lbs mono with 3 x 13/0 circle hooks for catching Striped Trumpter as well as other deep-sea fish.

HOOK SIZE: 13/0 Circle
NO. OF HOOKS: 3



Hayabusa Snapper Rigs

FSH2498

HOOK SIZE: 5/0
COLOUR:
Pink Flasher
Green Red Flasher
White Flasher



Hayabusa Snapper Rigs

FSH2520

HOOK SIZE: 6/0
COLOUR:
Pink Flasher
Green Red Flasher
White Flasher



Seamaster Deep Drop Rig

FSH1231PKTBOM

Designed and made by Seamaster using 400lbs mono with 5 x 14/0 circle hooks for catching Trevalla as well as other deep-sea fish.

HOOK SIZE: 14/0 Circle
NO. OF HOOKS: 5



Hayabusa Whiting Rigs

FSH1358









Includes two #10 high quality, Japanese Hayabusa hooks per rig and Japanese fluorocarbon line. Two rigs per package. Great for catching King George Whiting and Sand Whiting and excellent for catching Tasmanian bait fish.

PROFESSIONAL SQUID GEAR

Arrow Squid

					
FSH2480	FSH2320	FSH2319	FSH2321	FSH2353	FSH2352
Sinker Iron WEGHT: 1.2kg	Sinker Iron WEGHT: 1.5kg	Sinker Iron WEGHT: 1.8kg	Sinker Iron WEGHT: 2.0kg	Wire S/S Black Nylon LENGTH: 2000mm WIDTH 1.5/1.8mm	Squid Mono #80 LENGTH: 1000mm QUANTITY: 500pkt
					
FSH2315	FSH2316	FSH2317	FSH2318		
Hard Bodied Coloured Squid Lure	Hard Bodied Lumo Squid Lure	Soft Bodied Coloured Squid Lure	Hard Bodied Lumo Squid Lure		

Calamari

					
				FSH2505	PL0440
				Yamashita 3.5 Cloth Covered Calamari Jig SIZE: 105mm	DTD Croation squid jigs. Available in 5 different sizes and 35 different colours.
					
FSH1080	FSH2005	FSH2006	FSH2671	FSH2673	FSH1296
Yozuri Red Head Calamari jig SIZE: 105mm	Yoshikawa Red Head 3.5 SIZE: 105mm	Yoshikawa Red Head 4.0 SIZE: 105mm	Yoshikawa Parrot 3.5 SIZE: 120mm	Yoshikawa Parrot 3.5 SIZE: 120mm	Scalor Bag Custom Heavy Duty

SINKERS



Snapper Sinker			
PRODUCT CODE	SIZE	PRODUCT CODE	SIZE
FSH2007	4oz	FSH0157	22oz
FSH1202	6oz	FSH0158	24oz
FSH1059	8oz	FSH0922	32oz
FSH1060	10oz	FSH0923	44oz
FSH1176	12oz	FSH2257	70oz
FSH0156	16oz		

Snapper Sinker Mould	
PRODUCT CODE	SIZE
FSH1344	4oz
FSH1345	6oz
FSH1346	8oz
FSH1310	16oz
FSH1311	24oz
FSH1312	32oz

TUNA OIL

Berley and Tuna Oil

Improve your chances of catching fish with our range of locally produced berley and tuna oil. Bring the fish to you with the help of these great fish attracting logs, pellets and tuna oils.

					
PL0214	PL0217	PL0218	PL2355	PL4224	
Berley Pellets	Tuna Log	Tuna Tossers	Tuna Oil	Pilchard Pellets	
1kg	1kg	1kg	1L	750g	

TERMINAL TACKLE

Rigging and Tubing

Our range of stainless Kanseki springs, thimbles and polyester tubing assist in neat rigging of lures and baits and offers protection against chaffing and wearing on monofilament and fluorocarbon leader lines. Popular with sport and game fishermen.



Kanseki Spring Stainless Steel		
FSH0353	SIZE: 1.5mm	QUANTITY: each
FSH0618	SIZE: 1.8mm	QUANTITY: each
FSH0619	SIZE: 2.1mm	QUANTITY: each
FSH0354	SIZE: 2.3mm	QUANTITY: each



Braided Polyester Tubing 9cm		
PL0259	SIZE: 1.8mm	QUANTITY: 500 pc
PL0260	SIZE: 2.0mm	QUANTITY: 500 pc
PL0261	SIZE: 2.2mm	QUANTITY: 500 pc
PL0262	SIZE: 2.4mm	QUANTITY: 500 pc



Rigging Thimbles Stainless Steel		
PL2298	SIZE: 1.8mm - 2.2mm	QUANTITY: each

Shark Clips

We have a range of Japanese style stainless steel shark clips for use on monofilament and rope longlines. Available in 86mm, 100mm and 125mm lengths and offered either with or without BL swivel. Available in a U-Notch clip for movement on a longline, or a V-Notch clip for extra holding strength and minimal movement. Suitable for all types of pelagic, demersal finfish and shark longlining.



V-Notch Japanese Style Snaps NO SWIVEL			
FSH0143			
SIZE: 86 x 2mm QUANTITY: each	SIZE: 100 x 2.6mm QUANTITY: each	SIZE: 86 x 2mm QUANTITY: 100pc	SIZE: 100 x 2.6mm QUANTITY: 50pc



V-Notch Japanese Style Snaps with BL SWIVEL			
FSH0145			
SIZE: 86 x 2mm QUANTITY: each	SIZE: 100 x 2.6mm QUANTITY: each	SIZE: 86 x 2mm QUANTITY: 100pc	SIZE: 100 x 2.6mm QUANTITY: 50pc



U-Notch Japanese Style Snaps NO SWIVEL			U-Notch Japanese Style Snaps with BL SWIVEL		
FSH0137	FSH0134	FSH0135	FSH0141	FSH0138	FSH0139
SIZE: 86 x 2mm QUANTITY: each	SIZE: 100 x 2.6mm QUANTITY: each	SIZE: 125 x 3.5mm QUANTITY: each	SIZE: 86 x 2mm QUANTITY: each	SIZE: 100 x 2.6mm QUANTITY: each	SIZE: 125 x 3.5mm QUANTITY: each



U-Notch Japanese Style Snaps NO SWIVEL			U-Notch Japanese Style Snaps with BL SWIVEL		
PL2006	PL2002	PL2004	PL3353	PL2003	PL2005
SIZE: 86 x 2mm QUANTITY: 100pc	SIZE: 100 x 2.6mm QUANTITY: 50pc	SIZE: 125 x 3.5mm QUANTITY: 25pc	SIZE: 86 x 2mm QUANTITY: 100pc	SIZE: 100 x 2.6mm QUANTITY: 50pc	SIZE: 125 x 3.5mm QUANTITY: 25pc

SWIVELS

We offer a diverse selection of swivels designed to meet the needs of both recreational and commercial users. All our swivels are crafted from premium materials and meticulously finished to meet high standards. Our product range includes compact swivels for use with lightweight tackle as well as larger swivels tailored for heavier applications.

Black Crane Swivels



PRODUCT CODE	SIZE	BREAK STRENGTH (KG)
PL2141	1	42
PL2143	1/0	60
PL2145	2/0	108
PL2147	3/0	125
PL2149	4/0	140
PL2151	5/0	155
PL2153	6/0	180
PL2154	8/0	210

Ball Bearing Swivels with Coastlock Snap



PRODUCT CODE	SIZE	BREAK STRENGTH (KG)
FSH1270	1/0	13
FSH1271	2/0	20
FSH1272	3/0	33
FSH1273	4/0	65
FSH1274	5/0	90
FSH1275	6/0	125
FSH1276	7/0	175
FSH1277	8/0	225

Black Crane Combination 3-way Swivels



PRODUCT CODE	SIZE	BREAK STRENGTH (KG)
PL2130	1 + 1/0	39
PL2129	1/0 + 2/0	48
PL2131	2/0 + 3/0	55
PL2132	3/0 + 4/0	60
PL2133	4/0 + 5/0	72
PL2134	5/0 + 6/0	85

Crane Swivel with Sleeve (Bran)



PRODUCT CODE	SIZE	BREAK STRENGTH (KG)
PL3434	1.3mm + #1	42
FSH0268	1.6mm + #1	48
FSH0350	1.8mm + #1	55
FSH0269	2.0mm + 1/0	60
FSH0270	2.3mm + 2/0	90
FSH0351	3.0mm + 3/0	125
FSH0352	3.3mm + 4/0	140

Leaded, Corkscrew and Nickel Swivels

PL2174 Futaba Swivel S/S SIZE: #1	PL1293 Leaded Swivel S/S SIZE: 45g	PL1294 Leaded Swivel S/S SIZE: 60g	PL2127 Box Swivel S/S SIZE: 10/0	PL2179 H/D W/Corkscrew Swivel SIZE: 9mm	PL2178 H/D W/Corkscrew Swivel SIZE: 12mm
PL2182 H/D Nickel Swivel SIZE: 6mm	PL2184 H/D Nickel Swivel SIZE: 9mm	PL2180 H/D Nickel Swivel SIZE: 10.5mm	PL2181 H/D Nickel Swivel SIZE: 12mm		

STAINLESS STEEL WIRE

Our range of stainless steel wire is popular with recreational and commercial fishers rigging for shark and pelagic fish species, as well for industrial and mining applications. Manufactured in SS Grade 316 in 7x7 strand construction. Offered in size 0.8mm up to 6.0mm in uncoated, and in sizes 0.8mm up to 3.0mm in nylon coated wire. **Ask us about copper swages to suit.**

Uncoated



Wire 7x7 strand Uncoated Stainless Steel Grade 316			
PRODUCT CODE	DIAMETER	WEIGHT (KG)	LENGTH
MRH008	0.8mm	62	300m
MRH010	1.0mm	98	300m
MRH012	1.2mm	120	300m
MRH014	1.6mm	202	300m
MRH220	2.0mm	296	300m
PL3499	3.0mm		200m
PL3500	5.0mm		100m
PL3928	6.0mm		100m

Nylon Coated



Wire 7x7 strand Stainless Steel Grade 316 Nylon Coated Blue			
PRODUCT CODE	DIAMETER	WEIGHT (KG)	LENGTH
MRH009	0.8-1.0mm	62	300m
MRH011	1.0-1.2mm	98	300m
MRH013	1.2-1.5mm	120	300m
MRH015	1.6-2.0mm	202	300m
MRH219	2.0-2.4mm	296	300m
PL2545	2.6-3.0mm	453	200m
PL4152	3.0-3.5mm	610	100m
PL4471	3.5-4.0mm	720	200m
PL4472	4.5-5.0mm	915	100m

05 FLOATS & FENDERS

- > Mooring Buoys
- > Deepsea Pressure Floats
- > Aquaculture Floats and Markers
- > Foam Floats
- > QE NZ Floats
- > Polyform Inflatable
- > Marine Construction Float
- > Heavy Duty Ship Fenders
- > Fender Covers
- > Accessories













We carry a wide range of floats and fenders including world renowned Norwegian Polyform inflatable buoys and fenders.

As well as Australian made styrene floats, pressure buoys and large rotationally moulded mooring buoys and aquaculture lease markers, Seamaster's plastic fabricating abilities mean products can be developed to suit your requirements.

MOORING BUOYS

					
FLT144- Blue	FLT144- Red	FLT144- Orange	FLT144- Yellow	FLT145	FLT146
144L Mooring Float with Lugs or Centre Pipe	144L Mooring Float with Lugs or Centre Pipe	144L Mooring Float with Lugs or Centre Pipe	144L Mooring Float with Lugs or Centre Pipe	166L Mooring Durabuooy - Yellow 2210 x 600mm	166L Mooring Durabuooy - Orange 2210 x 600mm
					
FLT147	FLT156	FLT148	FLT149	FLT150	FLT157
166L Mooring Durabuooy - Blue 2210 x 600mm	166L Mooring Durabuooy - Red 2210 x 600mm	310L Mooring Durabuooy - Yellow 2440 x 600mm	310L Mooring Durabuooy - Orange 2440 x 600mm	310L Mooring Durabuooy - Blue 2440 x 600mm	Mooring Buoy Polyform CC4 Red 1485 x 800mm
					
FLT161	FLT162	FLT163	FLT164		
Mooring Buoy Polyform CCE4 with Rod 590 x 855mm	Mooring Buoy Polyform CC2 Red 430 x 385mm	Mooring Buoy Polyform CCE3 with Short Rod	Mooring Buoy Polyform MB100 Foam Filled Yellow		

DEEPSEA PRESSURE FLOATS

					
FLT001	FLT016	FLT018	FLT142	FLT151	FLT058
Pressure Float Hydrodynamic 200mm 1700m Centre Hole	Pressure Float Orange 200mm 1500m 7B-15 Centre Hole	Pressure Float Orange 120mm 100m 4M-10 Lugs	Pressure Float Orange 300mm TF300A	Pressure Float Orange 360mm TF360A	Pressure Float Orange 210mm 500m 7M-5
					
FLT059	PL0620	PL2744	PL0638	PL0639	FLT101
Pressure Float Orange 300mm 500m 10M-5	Pressure Float Orange 200mm 300m 7B-3 Centre Hole	Pressure Float Orange 150mm 1200m 5M-12 Centre Hole	Pressure Float Orange 300mm 300m 10M-3 Twin Lug	Pressure Float Orange 300mm 300m TF-300D Threaded End	Pressure Float White 240m 300m 240A Twin Lug
					
PL0684	PL0685	PL0687			
Pressure Float Orange Oval 85mm 300m 2G-3 Centre Hole	Pressure Float Orange Oval 145mm 300m 5G-3 Centre Hole	Pressure Float Black Oval 127mm 400m T-250 Centre Hole			

AQUACULTURE FLOATS AND MARKERS

					
MRH021	MRH0210	MFL021Y	FLT098	MFL001/2/3	MRH382
Conical Oyster Float	Buoy Conical Float 70lt Orange	Buoy Conical Float 70lt Yellow	Torpedo Sub Tidal Oyster Float	290L Mussel Float Assorted Colours	Corner Marker
					
MRH368	FLT172	FLT173			
Spar Marker 700mm	Sealite Marker Buoy Red	Sealite Marker Buoy Green			

FOAM FLOATS

						
FLT027	FLT023	FLT024	FLT025	FLT026	FLT021	
EVA Foam Float BL-S White	EVA Foam Float BL-2 White	EVA Foam Float BL-6 White	EVA Foam Float BL-7 Yellow	EVA Foam Float BL-8 Yellow	EVA Foam Float BL-10 Yellow	
						
PL0626	FLT022	PL0628	FLT166	FLT108	FLT154	
EVA Foam Float BL-12 Yellow	EVA Foam Float BL-14 Yellow	EVA Foam Float BL-18 Yellow	EVA Float SHE-105 yellow	Gillnet Float	Shark Net Float 125g 1000m	
						
FLT092	FLT040	FLT041	FLT042	FLT038	FLT039	
Net Float Y-9	Float Polystyrene Hard 4" 100S White	Float Polystyrene Hard 6" 150S White	Float Polystyrene Hard 8" 200S White	Float Polystyrene Hard 10" 250S White	Float Polystyrene Hard 12" 300S White	
						
PL0243	FLT110	FLT165				
Float Polystyrene Hard 8" 200S Red	Float Polystyrene Hard 16" x 8" 400L Pole Float White	Float Polystyrene Hard 24" x 8" 600L Pole Float White				
QE NZ FLOATS						
			FLT174	FLT109	FLT180	FLT181
			QEL220 3-Rib Cray Pot Float Red	QEL220 3-Rib Cray Pot Float Orange	QEL315 Cray Pot Float Red	QEL315 Cray Pot Float Orange

POLYFORM INFLATABLE

					
FLT117	FLT117	FLT118	FLT119	FLT120	FLT121
Polyform Buoy A0 Red	Polyform Buoy A0 Orange	Polyform Buoy A0 Yellow	Polyform Buoy A1 Red	Polyform Buoy A1 Yellow	Polyform Buoy A2 Red
					
FLT122	FLT123	FLT124	FLT125	FLT184	FLT135
Polyform Buoy A3 Red	Polyform Buoy A4 Red	Polyform Buoy A5 Red	Polyform Buoy A6 Red	Polyform Buoy A7 Red	Polyform Buoy HL-1 Red
					
FLT136	FLT137	FLT138	FLT139	FLT126	FLT127
Polyform Buoy HL-2 Red	Polyform Buoy HL-3 Red	Polyform Buoy HL-1 Orange	Polyform Buoy HL-4 Red	Polyform Fender F-1	Polyform Fender F-2
					
FLT128	FLT129	FLT130	FLT131	FLT132	FLT133
Polyform Fender F-3	Polyform Fender F-4	Polyform Fender F-5	Polyform Fender F-6	Polyform Fender F-7	Polyform Fender F-8
					
FLT182	PL0664	PL0665	PL0662		
Polyform Fender F-13	Castro Buoy A-0 Ribbed 200mm Red	Castro Buoy A-0 Ribbed 200mm White	Castro Buoy NBO-0 40mm		

MARINE CONSTRUCTION FLOAT



FLT052

Pontoon Float

HEAVY DUTY SHIP FENDERS

PL2793	PL0581	PL4012	PL0583	PL0582	
EVA Rope Covered HD Fender 25 x 25 x 80cm	EVA Rope Covered HD Fender 48 x 48 x 80cm	EVA Rope Covered HD Fender 48 x 48 x 160cm	EVA Rope Covered HD Fender 90 x 90 x 90cm	EVA Rope Covered HD Fender 90 x 90 x 180cm	

FENDER COVERS

Handmade in the UK to suit the PolyformF-Series Fenders.

FLT204	FLT194	FLT167	FLT168	FLT169	FLT170
F1 (pair) COLOUR: Black	F2 (pair) COLOUR: Black	F3 (pair) COLOUR: Navy	F4 (pair) COLOUR: Navy	F5 (pair) COLOUR: Navy	F6 (single) COLOUR: Navy

FLT195	FLT196	FLT197
F7 (single) COLOUR: Black	F8 (single) COLOUR: Black	F11 (single) COLOUR: Black

ACCESSORIES

FSH0183	FSH0115	FSH0116
Bamboo Cane Pole 18-20' 35mm Butt	Float Saver Macca Yellow <19mm	Float Saver Macca Yellow <14mm

06 LIGHTING

- > Hand Held Lights
- > Navigation Lights
- > Solar Powered Navigation Aids
- > Fixed Work and Spotlights

Navigation Lights







Work Lights

Handheld spotlights and torches





















Carmanah and Sealite Navigation Beacons

- High quality 12- and 24-volt LED navigation lights from Hella marine and Aqua Signal.
- Light your work area and path ahead with Hella marine work, flood and spotlights.
- Waterproof and rechargeable handheld spotlights and signal torches.
- Solar powered Navigation Beacons for marking navigational hazards, marine farm leases, and the like.

HAND HELD LIGHTS

					
LHT100	LHT113	LHT087	LHT043	BHW918	LHT124
Spotlight Marine Waterproof Spot 300 Lumens Rechargeable	Spotlight Marine Waterproof Spot 500 Lumens Rechargeable	Spotlight Marine Waterproof Spot 1500 Lumens Rechargeable	JetBeam SSR50 LED Torch 960 Lumens Rechargeable	AXIS LED Waterproof Torch Floating 9 LED Battery	Torch Yellow Floating Waterproof 40 Lumens Battery
					
LHT086					
Torch Yellow Floating Waterproof 60 Lumens Battery					





NAVIGATION LIGHTS

					
LHT066	LHT068	LHT69	LHT70	LHT071	LHT103
Hella Navigation Light - 360 White Voltage: 24	Hella Navigation Light - Masthead Voltage: 24	Hella Navigation Light - Starboard Voltage: 24	Hella Navigation Light - Starboard Voltage: 24	Hella Navigation Light - Port Voltage: 24	LED Navigation Light Pair - Port & Starboard Voltage: 12
					
BHW475	BHW606	PL2951	PL2950	PL2952	PL2953
LED Nav Light 265mm pole 360 White Voltage: 12	LED Nav Light 600mm pole Removable - 360 White Voltage: 12	Aqua Signal Series 40 <50m vessel - Starboard Green Voltage: 24	Aqua Signal Series 40 <50m vessel Port Red Voltage: 24	Aqua Signal Series 40 <50m vessel Masthead White Voltage: 24	Aqua Signal Series 40 <50m vessel Stern White Voltage: 24
					
PL2949	PL2987	PL2948	LHT150	LHT151	LHT152
Aqua Signal Series 40 <50m vessel 360 Red Voltage: 24	Aqua Signal Series 40 <50m vessel 360 Green Voltage: 24	Aqua Signal Series 40 <50m vessel 360 White Voltage: 24	Nav Light <20m Vertical Mount Port Voltage: 12/24	Nav Light <20m Vertical Mount Starboard Voltage: 12/24	Nav Light <20m Vertical Mount Bi Colour (Red & Green) Voltage: 12/24
					
LHT153	LHT154	LHT155			
Nav Light <20m Vertical Mount Masthead/Steaming (White) Voltage: 12/24	Nav Light <20m Vertical Mount Stern (White) Voltage: 12/24	Nav Light <50m Surface Mount Anchor (All-Round White) Voltage: 12/24			

SOLAR POWERED NAVIGATION AIDS

					
LHT001	LHT002	PL1824	PL3422		
Carmanah M550 <2Nm Multi/Programmable Voltage: Solar	Carmanah M650H <4Nm Multi/Programmable Voltage: Solar	Sealite SL-60 Marine Lantern 2-3nm Yellow Voltage: Solar	Sealite SL-15 Marine Lantern 1-2nm Yellow Voltage: Solar		

FIXED WORK AND SPOTLIGHTS

					
LHT096	LHT097	LHT111	LHT063		
Hella HypaLUME Flood Light Spot/Flood 28,000 Lumens Voltage: 24/48 & 240	Hella RokLUME Work Light 390N Spot/Flood 7,800 Lumens Voltage: 24	Hella Sea Hawk 470 Combi Light Bar Spot/Flood 2,200 Lumens Voltage: 12/24	Hella Sea Hawk XLR Work Light Spot/Flood 1,500 Lumens Voltage: 12/24		

07 ELECTRICAL

- > Radio and Aerials
- > Batteries
- > Electric Winches
- > Switches, Sockets and Accessories

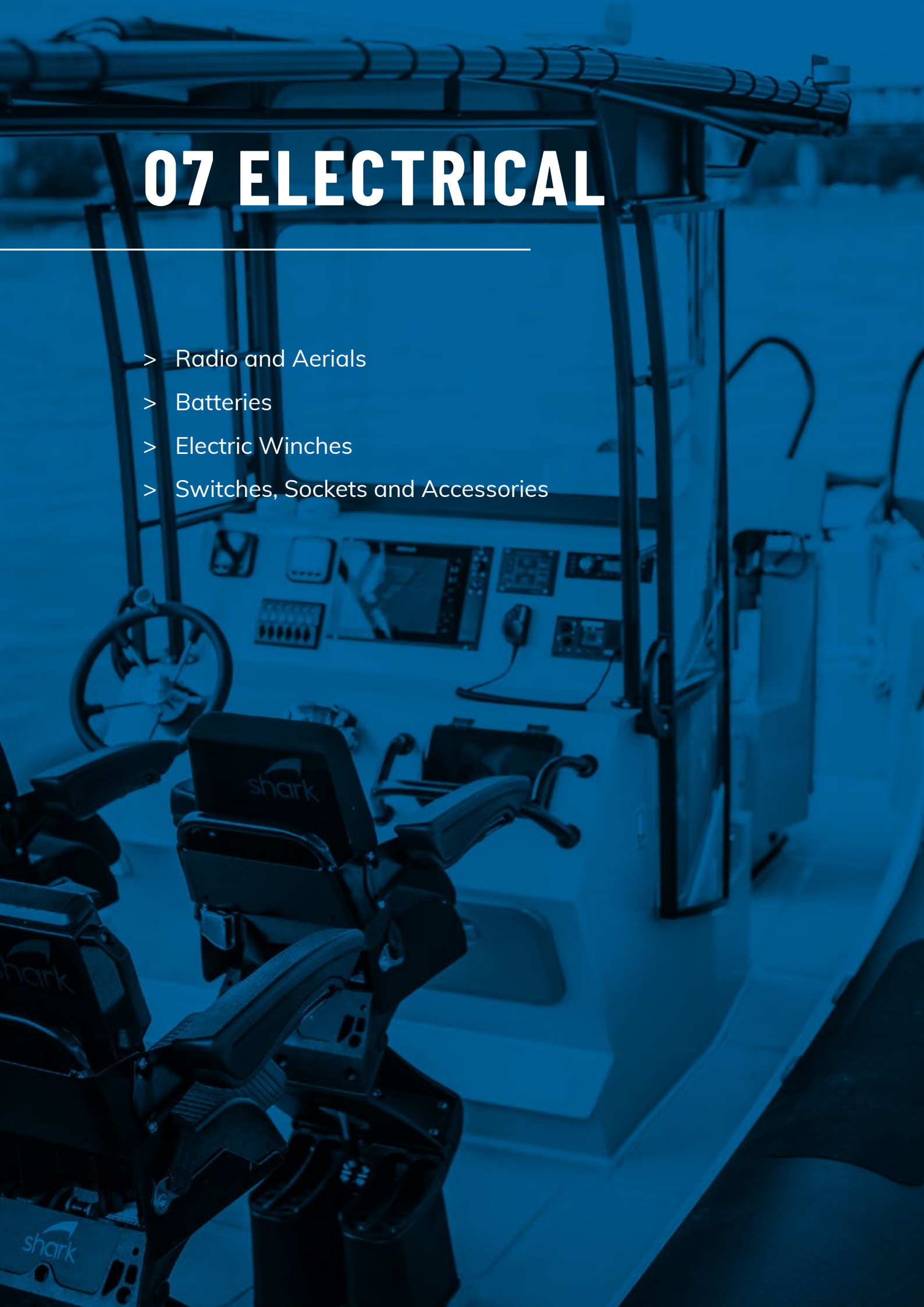

Electrical devices subject to the harsh marine environment must be of the highest quality, that is why Seamaster only stocks the top brands in marine electrics.

RADIO AND AERIALS

					
ELC240	PL1603	MHS127	ELC251	ELC241	ELC242
VHF Marine Radio Uniden UM455	GME VHF Marine Radio GX700	VHF Marine Hand Held Radio Uniden MHS127	Axis 1.0m VHF Aerial with Base	Axis 1.6m VHF Aerial with Base	Axis 2.4m VHF Aerial with Base
					
ELC125	ELC132	ELC124	PL1602	ELC210	
GME VHF Aerial Base	GME 1.2m VHF Aerial Whip	GME 1.8m VHF Aerial Whip	GME 2.4m VHF Aerial Whip	Moonraker Mobile Phone Aerial	



BATTERIES



ELC050

Full River Deep Cycle Battery

ELECTRIC WINCHES

					
BHW742	BHW850				
Maxwell Anchormax Capstan Winch 12V	Muir VC800 Vertical Capstan Winch 12V				

SWITCHES, SOCKETS AND ACCESSORIES

					
ELC041	ELC044	ELC018	ELC042	BHW771	ELC016
Switch Panel 4 Gang with Fuses	Switch Panel 6 Gang with Fuses	Switch Panel 5 Gang Power Socket and Fuses	Toggle Switch On/Off	BEP Dual Battery Distribution Cluster with DVSR	Battery Switch 600A Continuous
					
ELC019	ELC040	ELC015	ELC028	ELC029	ELC235
Battery Switch 235A 4 Position	Battery Switch On/Off with Key	Voltage Sensitive Relay	Power Socket Plastic 12V	Power Socket Stainless Steel 12V	BEP Circuit Breaker 30A
					
ELC236	ELC266	ELC267			
BEP Circuit Breaker 50A	Tinned Twin Core Electrical Wire 4mm per metre	Tinned Twin Core Electrical Wire 6mm per metre			



08 MOORING & RIGGING HARDWARE

- > Anchors
- > Chain
- > Shackles
- > Stainless Steel Hardware
- > Thimbles

We carry a large array of mooring components, hardware, and rigging in stainless steel and galvanised mild steel to cover all marine applications.

We source the highest quality chain and hardware for proven reliability for long term use in our oceans. We routinely splice 8-strand and 12-strand ropes for the multitude of mooring and buoy applications.

ANCHORS

Grapnel Anchor

Hot dip galvanised grapnel anchors offer a versatile and cost-effective anchor for use over rock, weed and sand substrate.



PRODUCT CODE	DESCRIPTION	WEIGHT (KG)	SUIT VESSEL SIZE
BHW437	Folding Grapnel Anchor	1.5	Up to 3.0m
PL0045	Folding Grapnel Anchor	2.5	Up to 4.0m
BHW439	Folding Grapnel Anchor	3.2	Up to 5.0m
BHW438	Grapnel Anchor No. 2	2	Up to 3.0m
PL2765	Grapnel Anchor No. 3	3	3.0m - 4.0m
PL0049	Grapnel Anchor No. 4	4	4.0m - 4.8m
PL0050	Grapnel Anchor No. 5	5	4.8m - 5.4m
PL0051	Grapnel Anchor No. 6	6	5.4m - 6.0m
PL0052	Grapnel Anchor No. 8	8	6.0m - 7.5m

SARCA Anchors

SARCA anchors are a hot dip galvanised anchor designed and manufactured in Australia. They offer a high-holding power anchor for use in sand, mud, gravel and rock. The sliding trip release allows the anchor to be pulled out backwards if lodged in rock.



PRODUCT CODE	DESCRIPTION	WEIGHT (KG)	SUIT VESSEL SIZE
PL2805	SARCA Anchor No.1	4	3.8 - 4.5m
PL0054	SARCA Anchor No.2	6	4.0 - 6.5m
PL0055	SARCA Anchor No.3	9	6.5 - 8.5m
BHW897	SARCA Anchor No.4		
PL4180	SARCA Anchor No.5	15	9.5 - 12.5m
PL4181	SARCA Bow Sprit S/S	Up to 17	

Sand

The galvanised Sand sanchor is a tried and tested very popular anchor to use on sand/mud sea floors. The downside to this style of anchor is that it doesn't perform very well on other sea bottoms.



PRODUCT CODE	WEIGHT (LB)
BHW446	6
BHW447	8
BHW448	10
BHW449	13
BHW450	18

Stockless JIS Anchors

Stockless JIS anchors are a popular anchor for larger commercial vessels operating in our southern waters. These hot dip galvanised anchors are supplied with Mill Certificate and are offered in sizes from 160kg to 350kg.



PRODUCT CODE	WEIGHT (KG)
PL3621	160
PL2839	180
PL2840	200
PL3622	220
PL0058	240
PL0059	280
PL0060	300
PL0061	350

Bruce / Claw

The bruce anchor is an excellent all-round anchor as it performs well in most sea bottoms including mud, sand, and rock. It finds it more difficult penetrating harder surfaces, such as clay, and sea floors with heavy grass. The three-claw design sets more easily than other's on the market.



Galvanised Self Aligning Anchor	
PRODUCT CODE	WEIGHT (KG)
BHW440	2
BHW441	5
BHW442	7.5
BHW443	10
BHW444	30
BHW675	50

Plough/CQR

The plough anchor is also ideal for mud or sand, suitable for heavier vessels and also fitted with a retrieval eye. It is lead filled in the tip to assist in setting the anchor into the seabed.



Galvanised Plough Anchor	
PRODUCT CODE	WEIGHT (LB)
BHW427	10
BHW428	15
BHW429	20
BHW430	27
BHW894	35
BHW431	45
BHW432	60

Plough/CQR Fixed

This anchor's new and improved shape and use of materials will reduce weight and increase durability to overall extend the performance and holding capabilities of the anchor.



Galvanised Plough Fixed Head Anchor	
PRODUCT CODE	WEIGHT (KG)
BHW433	4
BHW434	6
BHW435	10
BHW436	16

CHAIN

We stock a wide range of steel chain, both galvanised and self-coloured for all applications from swing moorings for large boats to anchor chain for dinghies.

Grade L Short Link Chain

Grade L chain, primarily used for anchoring in the marine industry is the highest quality lower tensile steel available for lifting purposes. Sold per metre.

The WWL (working load limit) states Grade L chain is rated for general conditions to group classification of crane mechanisms of M3 as specified in AS1418.1 for the conditions of use that apply.



PRODUCT CODE	DESCRIPTION	DESIGN 5:1 (LIFTING) WLL (TONNES)	DESIGN FACTOR 4:1 (MOORING) MWL (TONNES)	KG PER METRE (APPROX)	F (MM)	S (MM)	R (MM)
CHN013	Chain Galvanised Grade L 8mm	0.64	0.80	1.40	27	8	23.8
CHN008	Chain Galvanised Grade L 10mm	1.00	1.26	2.20	34.3	10	29.8
CHN009	Chain Galvanised Grade L 13mm	1.70	2.10	3.38	43	12.7	38
CHN010	Chain Galvanised Grade L 16mm	2.58	3.20	5.62	54.9	16	47.8

Imported Chain

A range of economical, imported chain for lighter duty applications. Sold per metre.

PRODUCT CODE	DESCRIPTION
CHN074	Chain Short Link 8mm Grade L
CHN075	Chain Short Link 10mm Grade L
CHN076	Chain Short Link 13mm Grade L

Unrated, Large Size Chain

Stud link and stud-less chain for large mooring applications where extra weight is required. Sold per metre.



PRODUCT CODE	DESCRIPTION
CHN004	Chain Studless U2 32mm x 27.5m
CHN027	Chain Studless U2 32mm Per Metre
CHN046	Chain Stud Link U2 50mm x 27.5m Tar coated
CHN047	Chain Stud Link U2 40mm x 27.5m Tar coated

PRODUCT CODE	DESCRIPTION
CHN081	Stud Link U2 40mm Tar coated Per Metre
CHN082	Stud Link U2 50mm Tar coated Per Metre
CHN078	Enlarged End Link

Regular Proof-Coil Chain

Manufactured from low carbon steel and proof tested to at least twice the maximum load recommended for normal use. Self-Coloured (non galvanised) chain primarily used in mooring applications when chain will be submersed continuously. Sold per metre.

Not suitable for industrial lifting purposes.

The MWL (Maximum working load) stated is for guidance in the selection of chain with sufficient strength for intended applications.



PRODUCT CODE	DESCRIPTION	MWL (TONNES)	KG PER METRE (APPROX)	F (MM)	S (MM)	R (MM)
CHN040	Chain Reg PC Galvanised 6mm Per Metre	0.32	0.74			
CHN041	Chain Reg PC Galvanised 8mm Per Metre	0.53	1.14			
CHN083	Chain Reg PC Self-Coloured Bulk 13mm	1.50	2.82	44.5	12	51.7
CHN005	Chain Reg PC Self-Coloured Bulk 16mm	2.31	5.26	57.3	16	59.6
CHN006	Chain Reg PC Self-Coloured Bulk 20mm	3.67	8.13	71	20	73.3
CHN007	Chain PWB Reg PC Self-Coloured Bulk 24mm	5.34	11.63	84.8	24	87

Mooring Chain Assemblies with End Links

Custom made mooring assemblies from PWB, made to fit each individual circumstance. Usually made up with self-coloured Grade L chain with over sized links each end to loop through itself.

PRODUCT CODE	DESCRIPTION
CHN063	20mm Gr-L x 22m, 1 Leg Assy
CHN066	20mm Gr-L Self Coloured x 26m Chain + End Links

Trailer Chain

Did you know that it is a requirement by most states and territories in Australia that your trailer chain needs to be of a certain standard? Our trailer chain is designed in accordance with AS/NZS4177.4. Come and see us today for your length of trailer chain so you can keep towing legally.



PRODUCT CODE	DESCRIPTION	WLL (TONNES)	m/1000KG
142008G	Trailer Chain Galvanised 8mm	1.6	91.1
142010G	Trailer Chain Galvanised 10mm	2.5	59.7

SHACKLES

Rated Galvanised D Shackles

D shackles are mainly used on one-leg systems whereas anchor or bow shackles are mainly used on multi-leg systems. The Grade M shackles are a rated shackle that comply with the requirements of AS 2741. Grade M shackles are commonly used in marine applications.



PRODUCT CODE	SIZE	WLL (TONNE)	TYPE	FINISH	SHAPE	CLOSING METHOD	WEIGHT (KG)
MRH115	10mm x 13mm	0.5	Grade M	Galvanised	D	Screw	0.16
MRH116	16mm x 19mm	1.5	Grade M	Galvanised	D	Screw	0.61
MRH117	20mm x 23mm	2	Grade M	Galvanised	D	Screw	1.1
MRH119	23mm x 25mm	3	Grade M	Galvanised	D	Screw	1.5

Rated Self Coloured D Shackles



PRODUCT CODE	SIZE	WLL (TONNE)	TYPE	FINISH	SHAPE	CLOSING METHOD	WEIGHT (KG)
MRH120	10mm x 13mm	0.5	Grade M	Self Colour	D	Screw	0.16
MRH121	13mm x 16mm	0.75	Grade M	Self Colour	D	Screw	0.35
MRH122	16mm x 19mm	1.5	Grade M	Self Colour	D	Screw	0.61
MRH123	20mm x 23mm	2	Grade M	Self Colour	D	Screw	1.1
MRH125	23mm x 25mm	3	Grade M	Self Colour	D	Screw	1.5
MRH124	25mm x 28mm	3.8	Grade M	Self Colour	D	Screw	2.14
MRH126	28mm x 32mm	5	Grade M	Self Colour	D	Screw	2.98
MRH127	32mm x 35mm	6	Grade M	Self Colour	D	Screw	3.1

Premium Self Coloured Grade D Shackles



PRODUCT CODE	SIZE	WLL (TONNE)	TYPE	FINISH	SHAPE	CLOSING METHOD	WEIGHT (KG)
MRH340	13mm x 16mm	0.75	Grade M	Self Colour	D	Screw	0.35
MRH337	16mm x 19mm	1.5	Grade M	Self Colour	D	Screw	0.61
MRH338	20mm x 23mm	2	Grade M	Self Colour	D	Screw	1.1
MRH339	23mm x 25mm	3	Grade M	Self Colour	D	Screw	1.5
230025	25mm x 28mm	3.8	Grade M	Self Colour	D	Screw	2.14
230028	28mm x 32mm	5	Grade M	Self Colour	D	Screw	2.98

Rated Wide Body Bow Shackle



PRODUCT CODE	DESCRIPTION	MINIMUM OPENING (MM)	TYPE
MRH350	Shackle Wide Body 25T	115	Bow
MRH305	Shackle Wide Body 55T	160	Bow

Galvanised Bow Shackle



> Not to be used for lifting

PRODUCT CODE	PIN DIAMETER (MM)
MRH107	5
MRH108	6
MRH109	8
MRH102	10
MRH104	16
MRH105	20

Seizing Wire



PRODUCT CODE	DESCRIPTION
MRH315	Seizing Wire S/S 1.60mm Per Metre

Rated Screw Pin Bow Shackles



- > Proof load 2.2 times of WLL
- > Hot dipped galvanised

PRODUCT CODE	SIZE	WLL (TONNE)	NOMINAL SIZE (INCHES)	PIN DIAMETER (INCHES)
MRH134	8mm	0.75	1/3	3/8
MRH139	10mm	1	3/8	1/8
MRH135	11mm	1.5	4/9	1/2
MRH141	13mm	2	1/2	5/8
MRH142	16mm	3.2	5/8	3/4
MRH144	19mm	4.7	3/4	7/8
MRH146	22mm	6.5	7/8	1
MRH147	25mm	8.5	1	1 1/8
MRH136	32mm	12	1 1/4	1 3/8
MRH137	35mm	13.5	1 3/8	1 1/2
MRH138	38mm	17	1 1/2	1 5/8
MRH140	44mm	25	1 3/4	2
MRH143	51mm	35	2	2 1/4

STAINLESS STEEL HARDWARE

Quality 316 grade stainless steel has many uses in the marine industry where corrosion resistance is required.

Stainless Steel Shackles

Strong and reliable 316 stainless shackles provide a corrosion resistant alternative to standard mild steel shackles.



PRODUCT CODE	DESCRIPTION	SIZE (MM)
MRH226	Dee Shackle Forged	4
MRH227	Dee Shackle Forged	5
MRH132	Dee Shackle Forged	6
MRH133	Dee Shackle Forged	8
MRH128	Dee Shackle Forged	10
MRH129	Dee Shackle Forged	12
MRH130	Dee Shackle Forged	16
MRH131	Dee Shackle Forged	19



PRODUCT CODE	DESCRIPTION	SIZE (MM)
MRH246	Long Dee Shackle	5
MRH247	Long Dee Shackle	6
MRH248	Long Dee Shackle	8
MRH244	Long Dee Shackle	10
MRH245	Long Dee Shackle	12

Stainless Steel Clips

A variety of stainless steel clips for fast and convenient attachments.



PRODUCT CODE	DESCRIPTION	SIZE (MM)
MRH261	Snap Hook	5
MRH262	Snap Hook	6
MRH263	Snap Hook	8
MRH260	Snap Hook	10
MRH429	Snap Hook	12



PRODUCT CODE	DESCRIPTION	SIZE (MM)
MRH242	Locking Snap Hook	6
MRH243	Locking Snap Hook	8
MRH241	Locking Snap Hook	10



PRODUCT CODE	DESCRIPTION	SIZE (MM)
FSH0642	Asymmetric Snap Hook	6
FSH0643	Asymmetric Snap Hook	8
FSH0641	Asymmetric Snap Hook	10
FSH0088	Asymmetric Snap Hook	12
MRH419	Asymmetric Snap Hook	16



PRODUCT CODE	DESCRIPTION	SIZE (MM)
MRH241	Snap Hook with Swivel Eye	10



PRODUCT CODE	DESCRIPTION	SIZE (MM)
BHW541	Snap Shackle with Swivel Eye	67
BHW542	Snap Shackle with Swivel Eye	89
BHW482	Snap Shackle with Swivel Eye	126

Swivels

Available in eye and eye or jaw and jaw configuration.



PRODUCT CODE	DESCRIPTION	SIZE (MM)
FSH0647	Swivel Jaw & Jaw	6
PL1883	Swivel Jaw & Jaw	8
FSH0644	Swivel Jaw & Jaw	10
FSH0645	Swivel Jaw & Jaw	12
FSH0646	Swivel Jaw & Jaw	16



PRODUCT CODE	DESCRIPTION	SIZE (MM)
MRH055	Swivel Eye & Eye	6
MRH056	Swivel Eye & Eye	8
MRH053	Swivel Eye & Eye	10
MRH408	Swivel Eye & Eye	13
MRH054	Swivel Eye & Eye	16

Eye Bolts and Anchor Points



PRODUCT CODE	DESCRIPTION	SIZE (MM)
MRH256	Short Eye Bolt	6
MRH257	Short Eye Bolt	8
MRH258	Short Eye Bolt	10
MRH259	Short Eye Bolt	12



PRODUCT CODE	DESCRIPTION	SIZE (MM)
MRH235	Eye Bolt	6
MRH236	Eye Bolt	8
MRH233	Eye Bolt	10
MRH234	Eye Bolt	12



PRODUCT CODE	DESCRIPTION	SIZE (MM)
MRH239	Eye Nut	6
MRH240	Eye Nut	8
MRH237	Eye Nut	10
MRH238	Eye Nut	12



PRODUCT CODE	DESCRIPTION	SIZE (MM)
BHW413	Eye Plate 50mm Square	8



PRODUCT CODE	DESCRIPTION	SIZE (MM)
MRH254	Saddle	5
MRH255	Saddle	6



PRODUCT CODE	DESCRIPTION	SIZE (MM)
MRH228	Diamond Eye Plate	50 x 80
MRH229	Diamond Eye Plate	57 x 89
MRH286	Diamond Eye Plate	60 x 100

Turnbuckles



PRODUCT CODE	DESCRIPTION	SIZE (MM)
MRH082	Turnbuckle Eye & Eye	6
MRH080	Turnbuckle Eye & Eye	10
PL3917	Turnbuckle Eye & Eye	12
MRH081	Turnbuckle Eye & Eye	16



PRODUCT CODE	DESCRIPTION	SIZE (MM)
MRH085	Turnbuckle Eye & Hook	6
MRH083	Turnbuckle Eye & Hook	10
MRH280	Turnbuckle Eye & Hook	12
MRH084	Turnbuckle Eye & Hook	16



PRODUCT CODE	DESCRIPTION	SIZE (MM)
MRH224	Closed Body Turnbuckle Jaw & Jaw	5
MRH361	Closed Body Turnbuckle Jaw & Jaw	6
MRH225	Closed Body Turnbuckle Jaw & Jaw	8
MRH223	Closed Body Turnbuckle Jaw & Jaw	10

Stainless Steel Wire Balustrading

We carry a wide range of wire balustrade fittings. Whether it is for your boat or your home there are options to suit your needs.



PRODUCT CODE	DESCRIPTION	SIZE (MM)
MRH277	Wire 316 7 x 7 1/8" Per Roll	1/8" 3.2
MRH299	Wire 316 7 x 7 1/8" Per Metre	1/8" 3.2
MRH416	Wire 316 7 x 7 5/32" Per Metre	5/32" 4.0



PRODUCT CODE	DESCRIPTION	SIZE (MM)
FSH0648	Nickel Plated Copper Swage	1/8" 3.2
FSH0920	Nickel Plated Copper Swage	5/32" 4.0













PRODUCT CODE	DESCRIPTION	SIZE (MM)
MRH388	Rigging Screw Swage & Jaw M5	1/8" 3.2
MRH389	Fork Terminal	1/8" 3.2
MRH417	Rigging Screw Swage & Jaw M6	5/32" 4.0
MRH418	Fork Terminal	5/32" 4.0

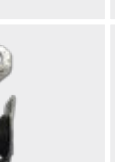

PRODUCT CODE	DESCRIPTION	SIZE (MM)
GCH181	Wire Lag Screw Left and Right Thread	1/8" 3.2

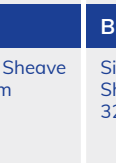
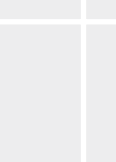
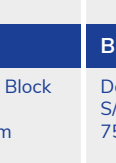
Pully Blocks

					
BHW223	BHW225	BHW221	BHW226	BHW227	BHW222
Single Loop Top 25mm x 6mm	Single Nylon Sheave 32mm x 10mm	Double Nylon Sheave 32mm x 10mm	Single Stainless Steel Sheave 32mm x 10mm	Single Nylon Sheave with Becket 50mm x 12mm	Double Nylon Sheave 50mm x 12mm
					
BHW481	BHW767	BHW722	BHW786	BHW723	GCH042
Double Nylon Sheave with Becket 50mm x 12mm	Single Open Snatch Block 50mm x 12mm	Single Snatch Block S/S Sheave 75mm x 14mm	Double Snatch Block S/S Sheave 75mm x 14mm	Single Seine Block 75mm x 20mm	Single Snatch Block 100mm x 16mm
					
BHW527	BHW417	BHW905	BHW906	BHW711	
Double Snatch Block 100mm x 16mm	Triple Snatch Block 100mm x 16mm	Daruma Block 1500kg 100mm x 16mm	Daruma Block 2500kg 150mm x 18mm	Single Block 2000kg 200mm x 32mm	

Stainless Steel Chain



PRODUCT CODE	DESCRIPTION	SIZE (MM)
CHN080	Medium Link Chain	3
CHN054	Medium Link Chain	4
CHN032	Medium Link Chain	6
SS-CH316-08M	Medium Link Chain	8
CHN037	Medium Link Chain	10
CHN062	Medium Link Chain	12

Stainless Steel Thimbles



PRODUCT CODE	DESCRIPTION	SIZE (MM)
MRH267	Thimble	2
MRH268	Thimble	3
MRH269	Thimble	4
MRH270	Thimble	5
MRH218	Thimble	6
MRH271	Thimble	8
MRH264	Thimble	10
MRH265	Thimble	12
MRH266	Thimble	16
MRH425	Thimble Heavy Wall	16
MRH216	Thimble Heavy Wall	20
MRH217	Thimble	25

THIMBLES

Galvanised



PRODUCT CODE	TYPE	SIZE (MM)
MRH179	Standard	6
MRH182	Standard	8
MRH061	Standard	10
MRH063	Standard	12
MRH168	Standard	14
MRH170	Standard	16
MRH172	Standard	20
MRH174	Standard	24



PRODUCT CODE	TYPE	SIZE (MM)
MRH178	Heavy Duty	6
MRH181	Heavy Duty	8
MRH060	Heavy Duty	10
MRH062	Heavy Duty	12
MRH167	Heavy Duty	14
MRH169	Heavy Duty	16
MRH171	Heavy Duty	20
MRH173	Heavy Duty	24
MRH175	Heavy Duty	32
MRH177	Heavy Duty	40

PRODUCT CODE	TYPE	SIZE (MM)
MRH176	Tubular	32



PRODUCT CODE	TYPE	SIZE (MM)
MRH183	Semi-Enclosed	32-40
MRH184	Semi-Enclosed	48-56
MRH185	Semi-Enclosed	56
MRH186	Semi-Enclosed	60-66
MRH187	Semi-Enclosed	68-72
MRH188	Semi-Enclosed	76-80
MRH180	Semi-Enclosed	80

Nylon



PRODUCT CODE	SIZE (MM)
GCH164	6
GCH165	8
GCH166	10

PRODUCT CODE	SIZE (MM)
GCH167	12
GCH168	14
GCH169	16

PRODUCT CODE	SIZE (MM)
GCH170	18
GCH171	20
GCH172	24



09 NEW ERA TANKS

- > Petrol Tanks 23 - 150 Litre
- > Diesel Tanks 23 - 150 Litre
- > Water Tanks 35 - 150 Litre
- > Tank Extras
- > Live Bait Tanks
- > Berley Buckets

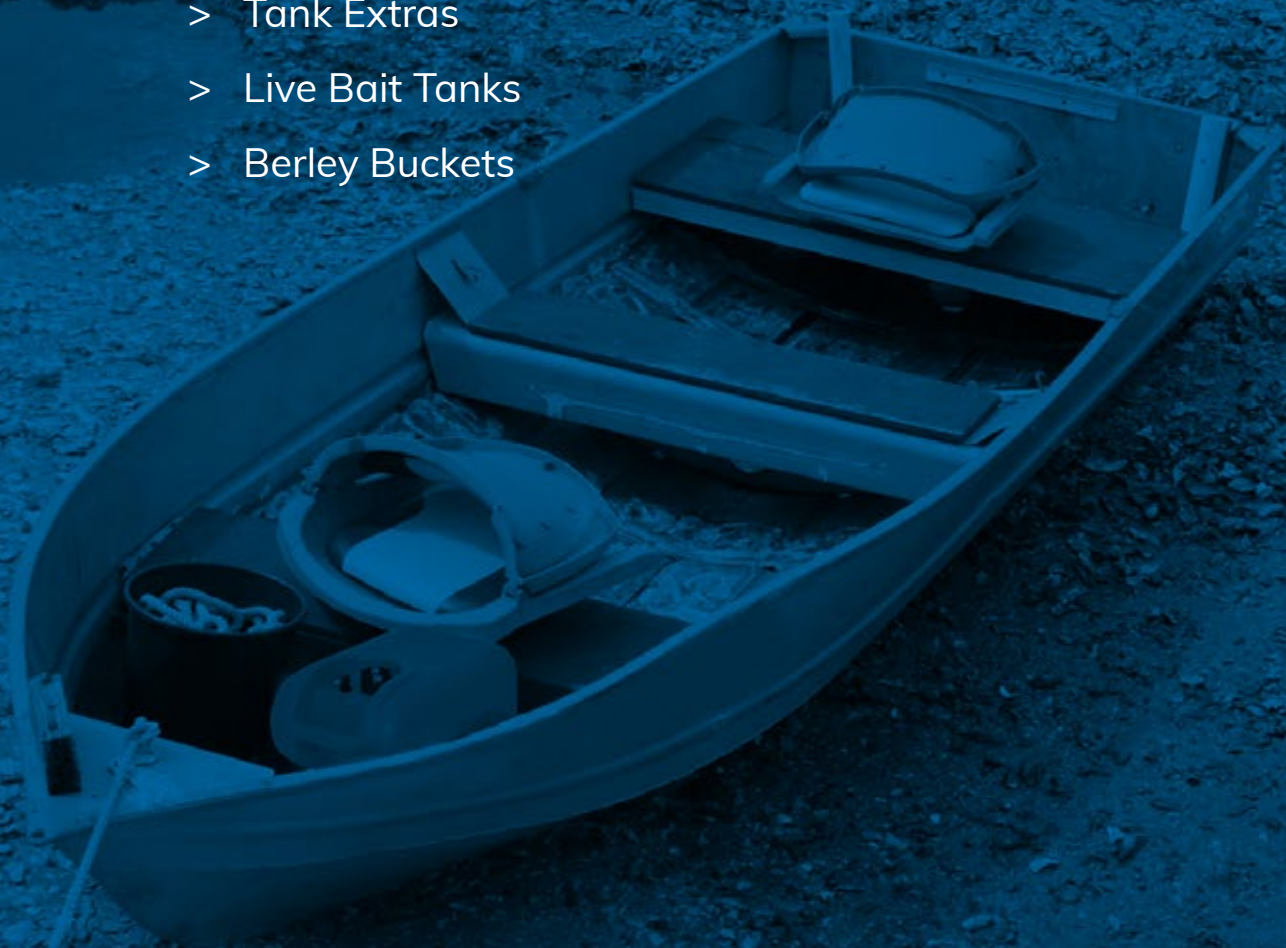

The New Era range of tanks are designed and built to suit Australian standards and expectations. The range, from 23 litre fuel tanks to 150 litre water tanks and are all produced in regional Victoria.

Tanks are used on boats, in caravans, on motorhomes, agricultural equipment, at remote locations, within engineering projects, on and around farms, at mining sites and anywhere safe and trouble-free storage of liquid products is required.

All tanks are rotationally moulded in one piece from UV stabilised polyethylene.

They are lightweight and will not rust. Fuel tanks are pressure tested to rigid specifications and are explosion proof in the event of a fire.

- Australian made
- Durable HDPE material construction
- Petrol, diesel, water and bait tanks
- Rotationally moulded
- Quality brass threaded inserts

23 Litre Pacemaker



LA1010
23L Petrol Tank

Vented cap, a nylon pick up with plastic tube and stainless steel filter.

Approved to AS2096 standards.

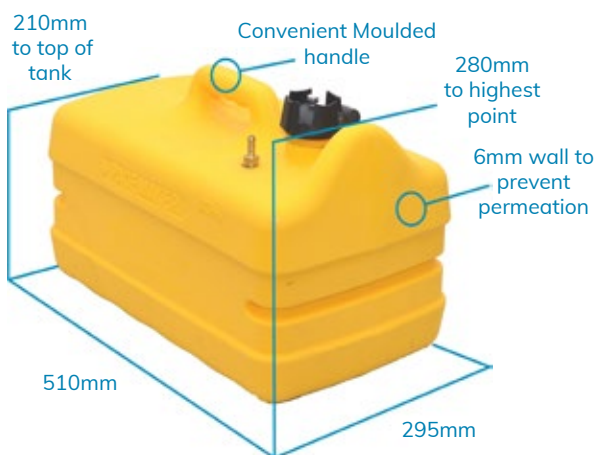

LA1020
23L Petrol Tank

Vented cap and mechanical gauge, a nylon pick up with plastic tube and stainless steel filter.

Approved to AS2096 standards.



LA1250
23L Diesel Tank

Vented cap, a nylon pick up with plastic tube and stainless steel filter and a 5/16 male brass tail fitted for return diesel fuel.



LA1270
23L Diesel Tank

Vented cap and mechanical gauge, a nylon pick up with plastic tube and stainless steel filter and a 5/16 male brass tail fitted for return diesel fuel.

25 Litre Fuel Tanks



Vented cap, a nylon pick up with plastic tube and stainless steel filter.

Approved to AS/NZ 2096:2001 standards

LA1500

25L Petrol Tank

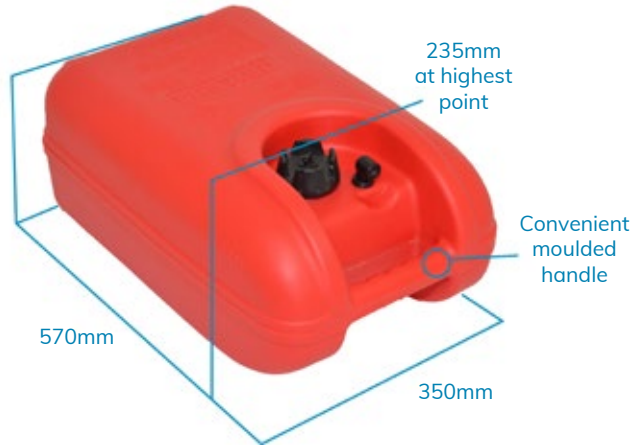

Vented cap and mechanical gauge, a nylon pick up with plastic tube and stainless steel filter.

Approved to AS/NZ 2096:2001 standards.

LA1520

25L Petrol Tank



Vented cap, a nylon pick up with plastic tube and stainless steel filter, plus a 5/16 male brass tail fitted, and a 5/16 male brass tail for return diesel fuel.

LA1750

25L Diesel Tank



Vented cap and mechanical gauge, a nylon pick up with plastic tube and stainless steel filter, plus a 5/16 male brass tail fitted, and a 5/16 male brass tail for return diesel fuel.

LA1770

25L Diesel Tank

28 Litre Fuel Tanks



38mm straight deck fill, a nylon pick up with plastic tube and stainless steel filter. Also includes a 3/8 male brass tail fitted in fuel pick up, a 32mm 1 1/4 brass insert to suit an electronic sender, and a 5/8 male tail plastic breather.

LA1830

28L Petrol Tank

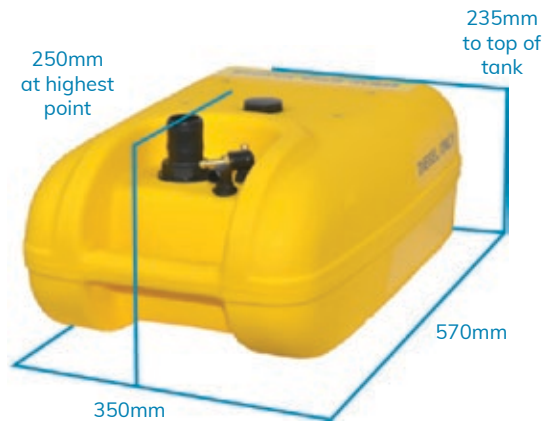

38mm 90 degree deck fill, a nylon pick up with plastic tube and stainless steel filter. Also includes a 3/8 male brass tail fitted in fuel pick up, a 32mm 1 1/4 brass insert to suit an electronic sender, and a 5/8 male tail plastic breather.

LA1850

28L Petrol Tank



38mm straight deck fill, a nylon pick up with plastic tube and stainless steel filter. It also has a 5/16 male brass tail fitted in fuel pick up, a 5/16 male brass tail for diesel return line, a 32mm 1 1/4 brass insert to suit an electronic sender, and a 5/8 male tail plastic breather.

LA1930

28L Diesel Tank



38mm 90 degree deck fill, a nylon pick up with plastic tube and stainless steel filter. It also has a 5/16 male brass tail fitted in fuel pick up, a 5/16 male brass tail for diesel return line, a 32mm 1 1/4 brass insert to suit an electronic sender, and a 5/8 male tail plastic breather.

LA1950

28L Diesel Tank

35 Litre Tanks

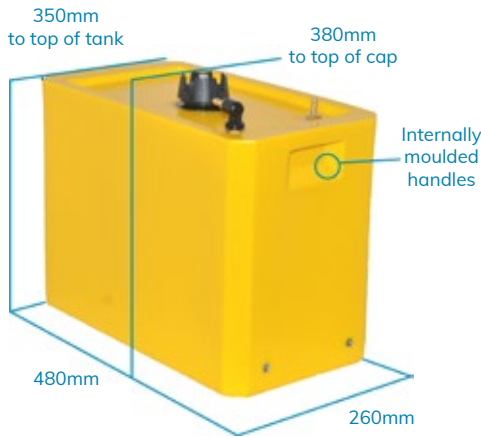

LA1970
35L Water Tank

Vented cap along with stainless M8 inserts for mounts and 2 x 3/4 threaded female outlets. Also includes a plastic 3/4 male hose tail.



LA1980
35L Diesel Tank

Vented cap, a nylon pick up with plastic tube and stainless steel filter, with a 5/16 male brass tail fitted in fuel pick up and a 5/16 male brass tail fitted for return diesel fuel.



LA1985
35L Diesel Tank

Vented cap, a 5/16 Gravity feed outlet and a 5/16 male brass tail fitted for return diesel fuel.



LA1990
35L Diesel Tank

38mm straight deck fill, a nylon pick up with plastic tube and stainless steel filter and a 5/16 male brass tail fitted in fuel pick up. It also has a 5/16 male brass tail fitted for return diesel fuel and a 5/8 Male tail plastic breather.

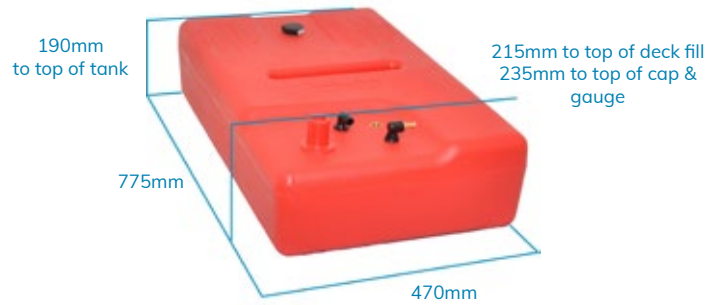

45 Litre Petrol Tanks



LA2252
45L Petrol Tank

Vented cap, a nylon pick up with plastic tube and stainless steel filter. Also includes a 3/8 male brass tail fitted in fuel pick up and a 32mm 1 1/4 brass insert to suit an electronic sender.



LA2005
45L Petrol Tank

Vented cap and mechanical gauge, a nylon pick up with plastic tube and stainless steel filter. Also includes a 3/8 male brass tail fitted in fuel pick up and a 32mm 1 1/4 brass insert to suit an electronic sender.



LA2010
45L Petrol Tank

38mm straight deck fill, a nylon pick up with plastic tube and stainless steel filter. Also includes a 3/8 male brass tail fitted in fuel pick up, a 32mm 1 1/4 brass insert to suit an electronic sender, and a 5/8 Male tail plastic breather.



LA2100
45L Petrol Tank

38mm 90 degree deck fill, a nylon pick up with plastic tube and stainless steel filter. Also includes a 3/8 male brass tail fitted in fuel pick up, a 32mm 1 1/4 brass insert to suit an electronic sender, and a 5/8 Male tail plastic breather.



LA2220
45L Petrol Tank

50mm straight deck fill, a nylon pick up with plastic tube and stainless steel filter. Also includes a 3/8 male brass tail fitted in fuel pick up, a 32mm 1 1/4 brass insert to suit an electronic sender, and a 5/8 Male tail plastic breather.



LA2225
45L Petrol Tank

Vented cap, a nylon pick up with plastic tube and stainless steel filter. Also includes a 3/8 male brass tail fitted in fuel pick up and a stainless steel fuel level sender 30 ~ 240 ohms with a 52mm fuel gauge.

45 Litre Diesel Tanks

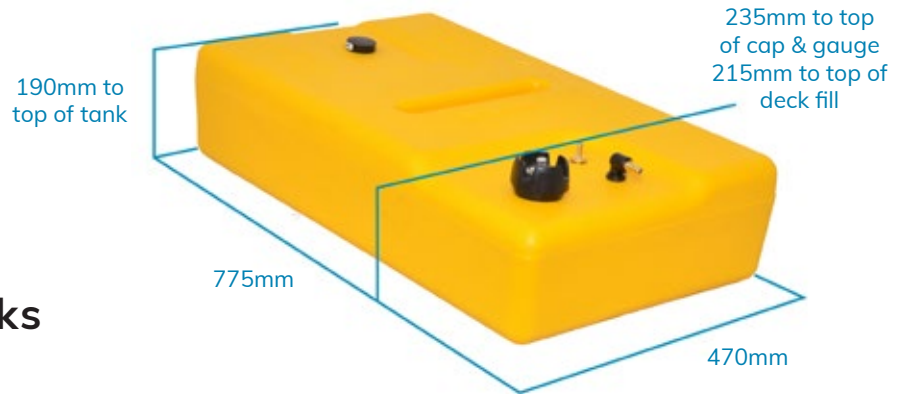

LA2252

45L Diesel Tank

Vented cap, a nylon pick up with plastic tube and stainless steel filter. It also has a 5/16 male brass tail fitted in fuel pick up, a 5/16 male brass tail for diesel return line, and a 32mm 1 1/4 brass insert to suit an electronic sender.



LA2254

45L Diesel Tank

Vented cap and mechanical gauge, a nylon pick up with plastic tube and stainless steel filter. It also has a 5/16 male brass tail fitted in fuel pick up, a 5/16 male brass tail for diesel return line, and a 32mm 1 1/4 brass insert to suit an electronic sender.



LA2350

45L Diesel Tank

38mm 90 degree deck fill, a nylon pick up with plastic tube and stainless steel filter. It also has a 5/16 male brass tail fitted in fuel pick up, a 5/16 male brass tail for diesel return line, a 32mm 1 1/4 brass insert to suit an electronic sender, and a 5/8 Male tail plastic breather.



LA2280

45L Diesel Tank

38mm straight deck fill, a nylon pick up with plastic tube and stainless steel filter. It also has a 5/16 male brass tail fitted in fuel pick up, a 5/16 male brass tail for diesel return line, a 32mm 1 1/4 brass insert to suit an electronic sender, and a 5/8 Male tail plastic breather.



LA2420

45L Diesel Tank

50mm straight deck fill, a nylon pick up with plastic tube and stainless steel filter. It also has a 5/16 male brass tail fitted in fuel pick up, a 5/16 male brass tail for diesel return line, a 32mm 1 1/4 brass insert to suit an electronic sender, and a 5/8 Male tail plastic breather.



LA2450

45L Diesel Tank

Vented cap, a nylon pick up with plastic tube and stainless steel filter. It also has a 5/16 male brass tail fitted in fuel pick up, a 5/16 male brass tail for diesel return line, a 5/8 Male tail plastic breather, and a stainless steel fuel level sender 30 ~ 240 ohms with a 52mm fuel gauge.

50 Litre Fuel Tanks



LA2500
50L Petrol Tank

Vented cap, a nylon pick up with plastic tube and stainless steel filter. It also has a 3/8 male brass tail fitted in fuel pick up and a 32mm 1 1/4 brass insert to suit an electronic sender.



LA2520
50L Petrol Tank

Vented cap and mechanical gauge, a nylon pick up with plastic tube and stainless steel filter. It also has a 3/8 male brass tail fitted in fuel pick up and a 32mm 1 1/4 brass insert to suit an electronic sender.



LA2530
50L Petrol Tank

38mm straight deck fill, a nylon pick up with plastic tube and stainless steel filter. It also includes a 3/8 male brass tail fitted in fuel pick up, a 32mm 1 1/4 brass insert to suit an electronic sender, and a 5/8 Male tail plastic breather.



LA2600
50L Petrol Tank

38mm 90 degree deck fill, a nylon pick up with plastic tube and stainless steel filter. It also includes a 3/8 male brass tail fitted in fuel pick up, a 32mm 1 1/4 brass insert to suit an electronic sender, and a 5/8 Male tail plastic breather.



LA2730
50L Petrol Tank

50mm straight deck fill, a nylon pick up with plastic tube and stainless steel filter. It also includes a 3/8 male brass tail fitted in fuel pick up, a 32mm 1 1/4 brass insert to suit an electronic sender, and a 5/8 Male tail plastic breather.



LA2780
50L Diesel Tank

Vented cap, a nylon pick up with plastic tube and stainless steel filter. It also includes a 5/16 male brass tail fitted in fuel pick up, a 5/16 male brass tail for diesel return line, and a stainless steel fuel level sender 30 ~ 240 ohms with a 52mm fuel gauge.



LA2790
50L Diesel Tank

Vented cap and mechanical gauge, a nylon pick up with plastic tube and stainless steel filter. It also includes a 5/16 male brass tail fitted in fuel pick up, a 5/16 male brass tail for diesel return line, and a 32mm 1 1/4 brass insert to suit an electronic sender.

55 Litre Tanks



Vented cap along with stainless M8 inserts for mounts and 2 x 3/4 threaded female outlets. Also includes a plastic 3/4 male hose tail.

LA3000

55L Water Tank

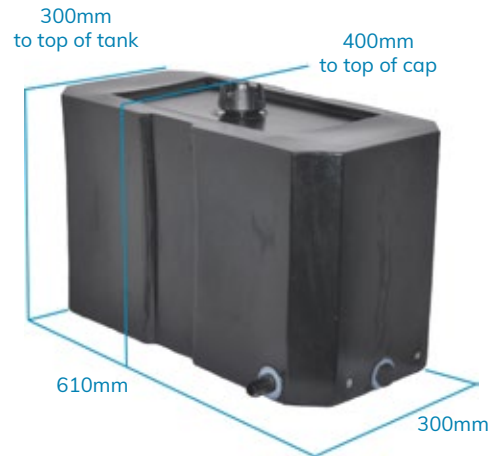

Vented cap, a nylon pick up with plastic tube and stainless steel filter, with a 5/16 male brass tail fitted in fuel pick up, and a 5/16 male brass tail fitted for return diesel fuel.

LA3050

55L Diesel Tank



Vented cap, a 5/16 Gravity feed outlet and a 5/16 male brass tail fitted for return diesel fuel.

LA3051

55L Diesel Tank



38mm straight deck fill, a nylon pick up with plastic tube and stainless steel filter and a 5/16 male brass tail fitted in fuel pick up. It also has a 5/16 male brass tail fitted for return diesel fuel, and a 5/8 Male tail plastic breather.

LA3055

55L Diesel Tank

60 Litre Water Tanks



Vented cap, a stainless steel water level sender 30 ~ 240 ohms with a 52mm fuel gauge, and a 5/8 male tail plastic breather. It also has a 20mm Female Outlet.

LA3710

60L Water Tank



38mm deck fill, a 32mm 1 1/4 brass to suit an electronic sender, and a 5/8 male tail plastic breather. It also has a 20mm Female Outlet.

LA3720

60L Water Tank



Vented cap, a 32mm 1 1/4 brass insert to suit an electronic sender, and a 20mm female outlet.

LA3701

60L Water Tank



38mm 90 degree deck fill, a 32mm 1/4 brass insert to suit an electronic sender, and a 5/8 male tail plastic breather. It also has a 20mm Female Outlet.

LA3725

60L Water Tank

60 Litre Petrol Tanks

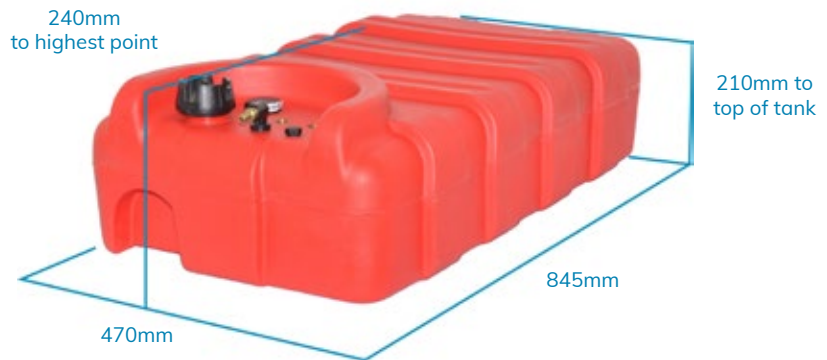

	<p>Vented cap, a nylon pick up with plastic tube and stainless steel filter. Also includes a 3/8 male brass tail fitted in fuel pick up, and a 32mm 1 1/4 brass insert to suit an electronic sender.</p>		<p>Vented cap and mechanical gauge, a nylon pick up with plastic tube and stainless steel filter. Also includes a 3/8 male brass tail fitted in fuel pick up, and a 32mm 1 1/4 brass insert to suit an electronic sender.</p>
<p>LA3400 60L Petrol Tank</p>		<p>LA3410 60L Petrol Tank</p>	
	<p>38mm straight deck fill, a nylon pick up with plastic tube and stainless steel filter. Also includes a 3/8 male brass tail fitted in fuel pick up, a 32mm 1 1/4 brass insert to suit an electronic sender, and a 5/8 Male tail plastic breather.</p>		<p>38mm 90 degree deck fill, a nylon pick up with plastic tube and stainless steel filter. Also includes a 3/8 male brass tail fitted in fuel pick up, a 32mm 1 1/4 brass insert to suit an electronic sender, and a 5/8 Male tail plastic breather.</p>
<p>LA3420 60L Petrol Tank</p>		<p>LA3465 60L Petrol Tank</p>	
	<p>50mm straight deck fill, a nylon pick up with plastic tube and stainless steel filter. Also includes a 3/8 male brass tail fitted in fuel pick up, a 32mm 1 1/4 brass insert to suit an electronic sender, and a 5/8 Male tail plastic breather.</p>		<p>Vented cap, a nylon pick up with plastic tube and stainless steel filter. Also includes a 3/8 male brass tail fitted in fuel pick up, a 5/8 Male tail plastic breather, and a stainless steel fuel level sender 30 ~ 240 ohms with a 52mm fuel gauge.</p>
<p>LA3490 60L Petrol Tank</p>		<p>LA3495 60L Petrol Tank</p>	

60 Litre Diesel Tanks

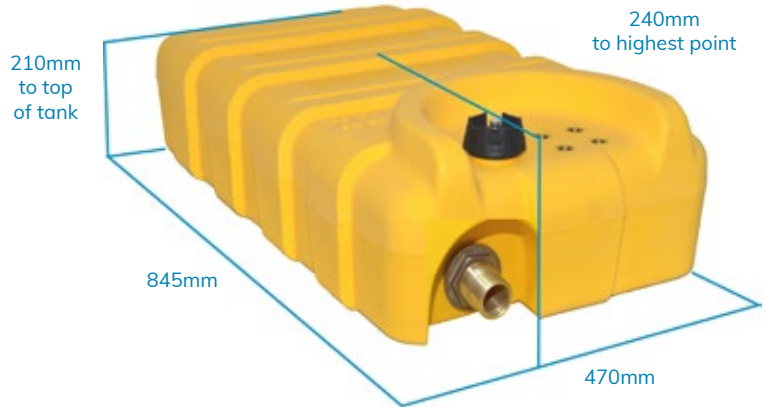

	<p>Vented cap, a nylon pick up with plastic tube and stainless steel filter. It also has a 5/16 male brass tail fitted in fuel pick up, a 5/16 male brass tail for diesel return line and a 32mm 1 1/4 brass insert to suit an electronic sender.</p>
<p>LA3505 60L Diesel Tank</p>	
	<p>Vented cap, a nylon pick up with plastic tube and stainless steel filter. It also has a 5/16 male brass tail fitted in fuel pick up, a 5/16 male brass tail for diesel return line, and a stainless steel fuel level sender 30 ~ 240 ohms with a 52mm fuel gauge.</p>
<p>LA3510 60L Diesel Tank</p>	
	<p>38mm straight deck fill, a nylon pick up with plastic tube and stainless steel filter. It also has a 5/16 male brass tail fitted in fuel pick up a 5/16 male brass tail for diesel return line, a 32mm 1 1/4 brass insert to suit an electronic sender, and a 5/8 Male tail plastic breather.</p>
<p>LA3525 60L Diesel Tank</p>	
	<p>Vented cap and mechanical gauge, a nylon pick up with plastic tube and stainless steel filter. It also has a 5/16 male brass tail fitted in fuel pick up, a 5/16 male brass tail for diesel return line and a 32mm 1 1/4 brass insert to suit an electronic sender.</p>
<p>LA3520 60L Diesel Tank</p>	
	<p>38mm 90 degree deck fill, a nylon pick up with plastic tube and stainless steel filter. It also has a 5/16 male brass tail fitted in fuel pick up a 5/16 male brass tail for diesel return line, a 32mm 1 1/4 brass insert to suit an electronic sender, and a 5/8 Male tail plastic breather.</p>
<p>LA3590 60L Diesel Tank</p>	
	<p>50mm straight deck fill, a nylon pick up with plastic tube and stainless steel filter. It also has a 5/16 male brass tail fitted in fuel pick up a 5/16 male brass tail for diesel return line, a 32mm 1 1/4 brass insert to suit an electronic sender, and a 5/8 Male tail plastic breather.</p>
<p>LA3655 60L Diesel Tank</p>	

75 Litre Fuel Tanks

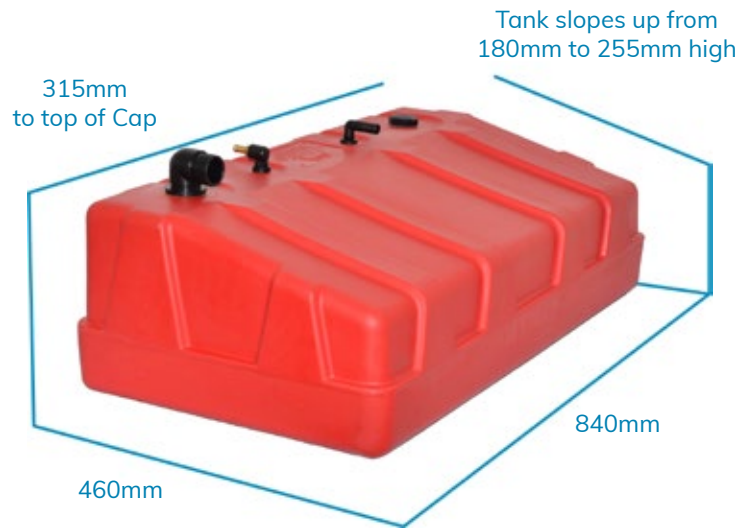

Vented cap, a nylon pick up with plastic tube and stainless steel filter. It also has a 3/8 male brass tail fitted in fuel pick up, and a 32mm 1 1/4 brass insert to suit an electronic sender.

LA3750
75L Petrol Tank



Vented cap and mechanical gauge, a nylon pick up with plastic tube and stainless steel filter. It also has a 3/8 male brass tail fitted in fuel pick up, and a 32mm 1 1/4 brass insert to suit an electronic sender.

LA3755
75L Petrol Tank



38mm straight deck fill, a nylon pick up with plastic tube and stainless steel filter. It also includes a 3/8 male brass tail fitted in fuel pick up, a 32mm 1 1/4 brass insert to suit an electronic sender, and a 5/8 Male tail plastic breather.

LA3760
75L Petrol Tank



38mm 90 degree deck fill, a nylon pick up with plastic tube and stainless steel filter. It also includes a 3/8 male brass tail fitted in fuel pick up, a 32mm 1 1/4 brass insert to suit an electronic sender, and a 5/8 Male tail plastic breather.

LA3850
75L Petrol Tank



50mm straight deck fill, a nylon pick up with plastic tube and stainless steel filter. It also includes a 3/8 male brass tail fitted in fuel pick up, a 32mm 1 1/4 brass insert to suit an electronic sender, and a 5/8 Male tail plastic breather.

LA3930
75L Petrol Tank



Vented cap and mechanical gauge, a nylon pick up with plastic tube and stainless steel filter. It also includes a 5/16 male brass tail fitted in fuel pick up, a 5/16 male brass tail for diesel return line, and a 32mm 1 1/4 brass insert to suit an electronic sender.

LA3970
75L Diesel Tank



Vented cap, a nylon pick up with plastic tube and stainless steel filter. It also includes a 5/16 male brass tail fitted in fuel pick up, a 5/16 male brass tail for diesel return line, and a stainless steel fuel level sender 30 ~ 240 ohms with a 52mm fuel gauge.

LA3980
75L Diesel Tank

80 Litre Petrol Tanks



	<p>Vented cap, a nylon pick up with plastic tube and stainless steel filter. Also includes a 3/8 male brass tail fitted in fuel pick up, and a 32mm 1/4 brass insert to suit an electronic sender.</p>	<p>LA4010 80L Petrol Tank</p>		<p>Vented cap and mechanical gauge, a nylon pick up with plastic tube and stainless steel filter. Also includes a 3/8 male brass tail fitted in fuel pick up, and a 32mm 1/4 brass insert to suit an electronic sender.</p>	<p>LA4040 80L Petrol Tank</p>
	<p>38mm straight deck fill, a nylon pick up with plastic tube and stainless steel filter. Also includes a 3/8 male brass tail fitted in fuel pick up, a 32mm 1/4 brass insert to suit an electronic sender, and a 5/8 Male tail plastic breather.</p>	<p>LA4060 80L Petrol Tank</p>		<p>38mm 90 degree deck fill, a nylon pick up with plastic tube and stainless steel filter. Also includes a 3/8 male brass tail fitted in fuel pick up, a 32mm 1/4 brass insert to suit an electronic sender, and a 5/8 Male tail plastic breather.</p>	<p>LA4150 80L Petrol Tank</p>
	<p>50mm straight deck fill, a nylon pick up with plastic tube and stainless steel filter. Also includes a 3/8 male brass tail fitted in fuel pick up, a 32mm 1/4 brass insert to suit an electronic sender, and a 5/4 Male tail plastic breather.</p>	<p>LA4220 80L Petrol Tank</p>		<p>Vented cap, a nylon pick up with plastic tube and stainless steel filter. Also includes a 3/8 male brass tail fitted in fuel pick up, and a stainless steel fuel level sensor 30 ~ 240 ohms with a 52mm fuel gauge.</p>	<p>LA4245 80L Petrol Tank</p>

80 Litre Water Tanks



LA4751
80L Water Tank

Vented cap, a 32mm 1 1/4 brass insert to suit an electronic sender, and a 20mm female outlet.



LA4760
80L Water Tank

38mm deck fill, a 32mm 1 1/4 brass insert to suit an electronic sender, and a 5/8 Male tail plastic breather. It also has a 20mm Female Outlet.



LA4770
80L Water Tank

38mm 90 degree deck fill, a 32mm 1 1/4 brass insert to suit an sender, and a 5/8 male tail plastic breather. It also has a 20mm Female Outlet.



LA4790
80L Water Tank

Vented cap, a nylon pick up with plastic tube and stainless steel filter and a 5/16 male brass tail fitted in fuel pick up. It also has a 5/16 male brass tail fitted for return diesel fuel, and a 5/8 Male tail plastic breather.

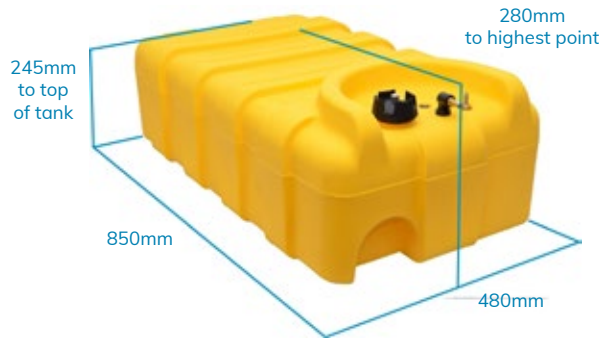

80 Litre Diesel Tanks



LA4251
80L Diesel Tank

Vented cap, a nylon pick up with plastic tube and stainless steel filter. It also has a 5/16 male brass tail fitted in fuel pick up, a 5/16 male brass tail for diesel return line, and a 32mm 1 1/4 brass insert to suit an electronic sender.

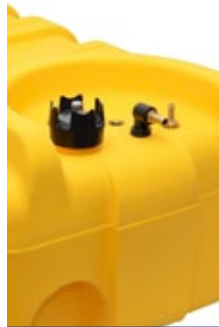

LA4290
80L Diesel Tank

Vented cap and mechanical gauge, a nylon pick up with plastic tube and stainless steel filter. It also has a 5/16 male brass tail fitted in fuel pick up, a 5/16 male brass tail for diesel return line, and a 32mm 1 1/4 brass insert to suit an electronic sender.



LA4300
80L Diesel Tank

38mm straight deck fill, a nylon pick up with plastic tube and stainless steel filter. It also has a 5/16 male brass tail fitted in fuel pick up, a 5/16 male brass tail for diesel return line, a 32mm 1 1/4brass insert to suit an electronic sender, and a 5/8 Male tail plastic breather.



LA4400
80L Diesel Tank

38mm 90 degree deck fill, a nylon pick up with plastic tube and stainless steel filter. It also has a 5/16 male brass tail fitted in fuel pick up, a 5/16 male brass tail for diesel return line, a 32mm 1 1/4brass insert to suit an electronic sender, and a 5/8 Male tail plastic breather.



LA4500
80L Diesel Tank

50mm straight deck fill, a nylon pick up with plastic tube and stainless steel filter. It also has a 5/16 male brass tail fitted in fuel pick up, a 5/16 male brass tail for diesel return line, a 32mm 1 1/4brass insert to suit an electronic sender, and a 5/8 Male tail plastic breather.



LA4550
80L Diesel Tank

Vented cap, a nylon pick up with plastic tube and stainless steel filter. It also has a 5/16 male brass tail fitted in fuel pick up, a 5/16 male brass tail for diesel return line, and a stainless steel fuel level sensor 30 ~ 240 ohms with a 52mm fuel gauge.

85 Litre Tanks

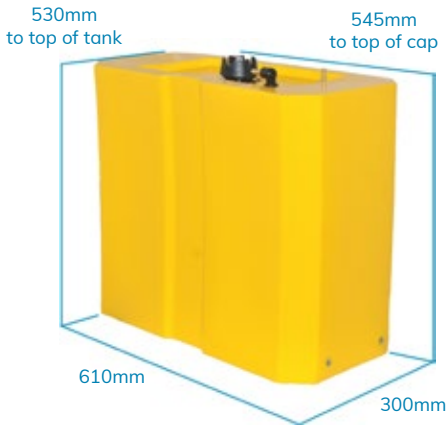

Vented cap along with stainless M8 inserts for mounts and 2 x 3/4 threaded female outlets. Also includes a plastic 3/4 male hose tail.

LA4800
85L Water Tank



85 Litre diesel tank with vented cap, a nylon pick up with plastic tube and stainless steel filter, with a 5/16 male brass tail fitted in fuel pick up, and a 5/16 male brass tail fitted for return diesel fuel.

LA4850
85L Diesel Tank



85 Litre diesel tank with vented cap, a 5/16 Gravity feed outlet, and a 5/16 male brass tail fitted for return diesel fuel.

LA4851
85L Diesel Tank



38mm straight deck fill, a nylon pick up with plastic tube and stainless steel filter and a 5/16 male brass tail fitted in fuel pick up. It also has a 5/16 male brass tail fitted for return diesel fuel, and a 3/8 Male tail plastic breather.

LA4860
85L Diesel Tank

90 Litre Petrol Tanks

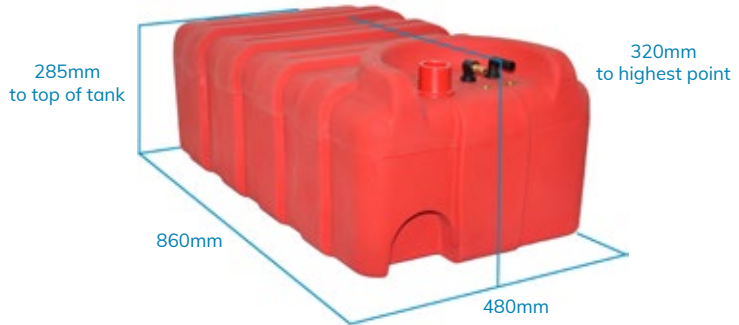

Vented cap, a nylon pick up with plastic tube and stainless steel filter. Also includes a 3/8 male brass tail fitted in fuel pick up, and a 32mm 1 1/4 brass insert to suit an electronic sender.

LA5020
90L Petrol Tank



Vented cap, a nylon pick up with plastic tube and stainless steel filter. Also includes a 3/8 male brass tail fitted in fuel pick up, and a stainless steel fuel level sensor 30 ~ 240 ohms with a 52mm fuel gauge.

LA5030
90L Petrol Tank



Vented cap and mechanical gauge, a nylon pick up with plastic tube and stainless steel filter. Also includes a 3/8 male brass tail fitted in fuel pick up, and a 32mm 1 1/4 brass insert to suit an electronic sender.

LA5040
90L Petrol Tank



38mm straight deck fill, a nylon pick up with plastic tube and stainless steel filter. Also includes a 3/8 male brass tail fitted in fuel pick up, a 32mm 1 1/4 brass insert to suit an electronic sender, and a 5/8 Male tail plastic breather.

LA5050
90L Petrol Tank



38mm 90 degree deck fill, a nylon pick up with plastic tube and stainless steel filter. Also includes a 3/8 male brass tail fitted in fuel pick up, a 32mm 1 1/4 brass insert to suit an electronic sender, and a 5/8 Male tail plastic breather.

LA5150
90L Petrol Tank



50mm straight deck fill, a nylon pick up with plastic tube and stainless steel filter. Also includes a 3/8 male brass tail fitted in fuel pick up, a 32mm 1 1/4 brass insert to suit and electronic sender, and a 5/8 Male tail plastic breather.

LA5230
90L Petrol Tank

90 Litre Water Tanks

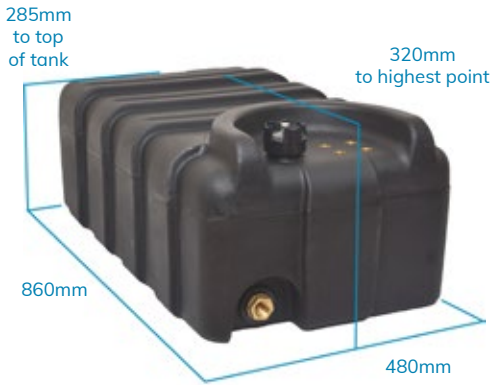

 <p>LA5751 90L Water Tank</p>	<p>Vented cap, a 32mm 1 1/4 brass insert to suit an electronic sender and a 20mm female outlet.</p>	 <p>LA5755 90L Water Tank</p>	<p>Vented cap, and a stainless steel water level sender 30 ~ 240 ohms with a 52mm fuel gauge, and a 5/8 male tail plastic breather. It also has a 20mm Female Outlet.</p>
 <p>LA5770 90L Water Tank</p>	<p>38mm deck fill, a 32mm 1 1/4 brass insert to suit an electronic sender and a 5/8 Male tail plastic breather. It also has a 20mm Female Outlet.</p>	 <p>LA5775 90L Water Tank</p>	<p>38mm 90 degree deck fill, a 32mm 1 1/4 brass insert to suit an electronic sender, and a 5/8 male tail plastic breather. It also has a 20mm Female Outlet.</p>

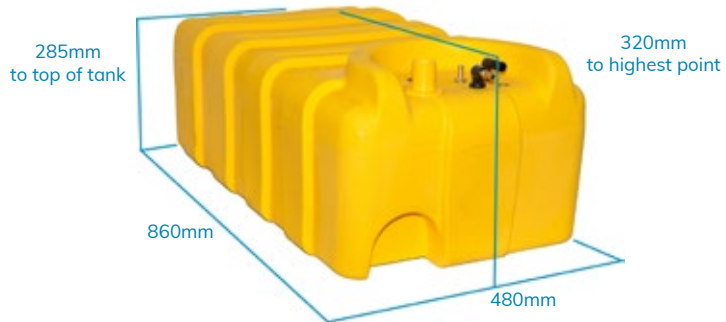

90 Litre Diesel Tanks

 <p>LA5251 90L Diesel Tank</p>	<p>Vented cap, a nylon pick up with plastic tube and stainless steel filter. It also has a 5/16 male brass tail fitted in fuel pick up, a 5/16 male brass tail for diesel return line, and a 32mm 1 1/4 brass insert to suit an electronic sender.</p>	 <p>LA5260 90L Diesel Tank</p>	<p>Vented cap, a nylon pick up with plastic tube and stainless steel filter. It also has a 5/16 male brass tail fitted in fuel pick up, a 5/16 male brass tail for diesel return line, and a stainless steel fuel level sender 30 ~ 240 ohms with a 52mm fuel gauge.</p>	 <p>LA5270 90L Diesel Tank</p>	<p>Vented cap and mechanical gauge, a nylon pick up with plastic tube and stainless steel filter. It also has a 5/16 male brass tail fitted in fuel pick up, a 5/16 male brass tail for diesel return line, and a 32mm 1 1/4 brass insert to suit an electronic sender.</p>
 <p>LA5300 90L Diesel Tank</p>	<p>38mm straight deck fill, a nylon pick up with plastic tube and stainless steel filter. It also has a 5/16 male brass tail fitted in fuel pick up, a 5/16 male brass tail for diesel return line, a 32mm 1 1/4 brass insert to suit an electronic sender, and a 5/8 Male tail plastic breather.</p>	 <p>LA5400 90L Diesel Tank</p>	<p>38mm 90 degree deck fill, a nylon pick up with plastic tube and stainless steel filter. It also has a 5/16 male brass tail fitted in fuel pick up, a 5/16 male brass tail for diesel return line, a 32mm 1 1/4 brass insert to suit an electronic sender, and a 5/8 Male tail plastic breather.</p>	 <p>LA5480 90L Diesel Tank</p>	<p>50mm straight deck fill, a nylon pick up with plastic tube and stainless steel filter. It also has a 5/16 male brass tail fitted in fuel pick up, a 5/16 male brass tail for diesel return line, a 32mm 1 1/4 brass insert to suit an electronic sender, and a 5/8 Male tail plastic breather.</p>

125 Litre Petrol Tanks



Vented cap, a nylon pick up with plastic tube and stainless steel filter. Also includes a 3/8 male brass tail fitted in fuel pick up, and a 32mm 1/4 brass insert to suit an electronic sender.

LA6010
125L Petrol Tank

38mm straight deck fill, a nylon pick up with plastic tube and stainless steel filter. Also includes a 3/8 male brass tail fitted in fuel pick up, a 32mm 1/4 brass insert to suit an electronic sender, and a 5/8 Male tail plastic breather.

LA6050
125L Petrol Tank

38mm 90 degree deck fill, a nylon pick up with plastic tube and stainless steel filter. Also includes a 3/8 male brass tail fitted in fuel pick up, a 32mm 1/4 brass insert to suit an electronic sender, and a 5/8 Male tail plastic breather.

LA6150
125L Petrol Tank

Vented cap, a nylon pick up with plastic tube and stainless steel filter. Also includes a 3/8 male brass tail fitted in fuel pick up, and a stainless steel fuel level sender 30 ~ 240 ohms with a 52mm fuel gauge.

LA6020
125L Petrol Tank

50mm straight deck fill, a nylon pick up with plastic tube and stainless steel filter. Also includes a 3/8 male brass tail fitted in fuel pick up, a 32mm 1/4 brass insert to suit an electronic sender, and a 5/8 Male tail plastic breather.

LA6230
125L Petrol Tank

125 Litre Diesel Tanks



Vented cap, and a 20mm female transfer outlet.

LA6250

125L Diesel Tank



Vented cap, a nylon pick up with plastic tube and stainless steel filter. It also has a 5/16 male brass tail fitted in fuel pick up, a 5/16 male brass tail for diesel return line, and a 32mm 1 1/4 brass insert to suit an electronic sender.

LA6251

125L Diesel Tank



Vented cap, a nylon pick up with plastic tube and stainless steel filter. It also has a 5/16 male brass tail fitted in fuel pick up, a 5/16 male brass tail for diesel return line, and a stainless steel fuel level sender 30 ~ 240 ohms with a 52mm fuel gauge.

LA6260

125L Diesel Tank



38mm straight deck fill, a nylon pick up with plastic tube and stainless steel filter. It also has a 5/16 male brass tail fitted in fuel pick up, a 5/16 male brass tail for diesel return line, a 32mm 1 1/4 brass insert to suit an electronic sender, and a 5/8 Male tail plastic breather.

LA6280

125L Diesel Tank



38mm 90 degree deck fill, a nylon pick up with plastic tube and stainless steel filter. It also has a 5/16 male brass tail fitted in fuel pick up, a 5/16 male brass tail for diesel return line, a 32mm 1 1/4 brass insert to suit an electronic sender, and a 5/8 Male tail plastic breather.

LA6350

125L Diesel Tank



50mm straight deck fill, a nylon pick up with plastic tube and stainless steel filter. It also has a 5/16 male brass tail fitted in fuel pick up, a 5/16 male brass tail for diesel return line, a 32mm 1 1/4 brass insert to suit an electronic sender, and a 5/8 Male tail plastic breather.

LA6430

125L Diesel Tank

125 Litre Water Tanks



LA6810

125L Water Tank

Vented cap, a 32mm 1 1/4 brass insert to suit an electronic sender and a 20mm female outlet.



LA6820

125L Water Tank

Vented cap, and a stainless steel fuel level sensor 30 ~ 240 ohms with a 52mm fuel gauge, and a 5/8 male tail plastic breather. It also has a 20mm Female Outlet.



LA6850

125L Water Tank

38mm deck fill, a 32mm 1 1/4 brass insert to suit an electronic sender, and a 5/8 Male tail plastic breather. It also has a 20mm Female Outlet.



LA6860

125L Water Tank

38mm 90 degree deck fill, a 32mm 1 1/4 brass insert to suit an electronic sender, and a 5/8 male tail plastic breather. It also has a 20mm Female Outlet.

150 Litre Water Tanks



LA7760

150L Water Tank

Vented cap, a 32mm 1 1/4 brass insert for fuel sender and a 20mm female outlet.



LA7770

150L Water Tank

Vented cap, and a stainless steel fuel level sensor 30 ~ 240 ohms with a 52mm fuel gauge, and a 5/8 male tail plastic breather. It also has a 20mm Female Outlet.



LA7800

150L Water Tank

38mm deck fill, a 32mm 1 1/4 brass insert for fuel sender and a 5/8 Male tail plastic breather. It also has a 20mm Female Outlet.



LA7810

150L Water Tank

38mm 90 degree deck fill, a 32mm 1 1/4 brass insert for fuel sender, and a 5/8 male tail plastic breather. It also has a 20mm Female Outlet.

150 Litre Petrol Tanks



	<p>Vented cap, a nylon pick up with plastic tube and stainless steel filter. Also includes a 3/8 male brass tail fitted in fuel pick up, and a 32mm 1 1/4 brass insert to suit an electronic sender.</p>
<p>LA7010 150L Petrol Tank</p>	
	<p>Vented cap, a nylon pick up with plastic tube and stainless steel filter. Also includes a 3/8 male brass tail fitted in fuel pick up, and a stainless steel fuel level sender 30 ~ 240 ohms with a 52mm fuel gauge.</p>
<p>LA7020 150L Petrol Tank</p>	
	<p>38mm straight deck fill, a nylon pick up with plastic tube and stainless steel filter. Also includes a 3/8 male brass tail fitted in fuel pick up, a 32mm 1 1/4 brass insert to suit an electronic sender, and a 5/8 Male tail plastic breather.</p>
<p>LA7050 150L Petrol Tank</p>	
	<p>38mm 90 degree deck fill, a nylon pick up with plastic tube and stainless steel filter. Also includes a 3/8 male brass tail fitted in fuel pick up, a 32mm 1 1/4 brass insert to suit an electronic sender, and a 5/8 Male tail plastic breather.</p>
<p>LA7150 150L Petrol Tank</p>	
	<p>50mm straight deck fill, a nylon pick up with plastic tube and stainless steel filter. Also includes a 3/8 male brass tail fitted in fuel pick up, a 32mm 1 1/4 brass insert to suit an electronic sender, and a 5/8 Male tail plastic breather.</p>
<p>LA7220 150L Petrol Tank</p>	

150 Litre Diesel Tanks



LA7500
150L Diesel Tank

Vented cap and 20mm female transfer outlet.



LA7501
150L Diesel Tank

Vented cap, a nylon pick up with plastic tube and stainless steel filter. It also has a 5/16 male brass tail fitted in fuel pick up, a 5/16 male brass tail for diesel return line and a 32mm 1 1/4 brass insert to suit an electronic sender.



LA7520
150L Diesel Tank

Vented cap, a nylon pick up with plastic tube and stainless steel filter. It also has a 5/16 male brass tail fitted in fuel pick up, a 5/16 male brass tail for diesel return line, and a stainless steel fuel level sender 30 ~ 240 ohms with a 52mm fuel gauge.



LA7540
150L Diesel Tank

38mm straight deck fill, a nylon pick up with plastic tube and stainless steel filter. It also has a 5/16 male brass tail fitted in fuel pick up a 5/16 male brass tail for diesel return line, a 32mm 1 1/4 brass insert to suit an electronic sender and a 5/8 Male tail plastic breather.



LA7605
150L Diesel Tank

38mm 90 degree deck fill, a nylon pick up with plastic tube and stainless steel filter. It also has a 5/16 male brass tail fitted in fuel pick up a 5/16 male brass tail for diesel return line, a 32mm 1 1/4 brass insert to suit an electronic sender and a 5/8 Male tail plastic breather.



LA7680
150L Diesel Tank

50mm straight deck fill, a nylon pick up with plastic tube and stainless steel filter. It also has a 5/16 male brass tail fitted in fuel pick up a 5/16 male brass tail for diesel return line, a 32mm 1 1/4 brass insert to suit an electronic sender and a 5/8 Male tail plastic breather.

Tank Extras



DESIGN

New Era tanks are designed and manufactured in Australia to Australian conditions. All our tanks are roto moulded giving a 6mm skin preventing permeation and providing a safe and strong product.



BRASS INSERTS

New Era tanks includes quality brass inserts moulded into the tanks during manufacturing. Many of our products include up to 4 3/8 inserts and some also have a 1 1/4 insert. This allows the user a multitude of choices regarding breathers, extra pick-ups, as well as electronic senders and gauges.



MALE TAILS

Many New Era tanks are sold with standardised brass male tail sizings. The buyer can request different sizes according to requirements..



90 DEGREE TAILS

Many New Era tanks are sold with straight brass male tail sizings. The buyer can request 90 degree tails according to requirements.



TRANSFER TANKS

For the quick transfer of fuel, our tanks can include a 20mm female brass outlet.



GRAVITY FEED

Our gravity feed options include stainless steel or brass fittings dependant on the product stored. Sizings include 3/8" and 5/16".



CROSSLINK

Our 125 litre and 150 litre petrol tanks are produced with crosslink polyethylene to ensure we provide you with the strongest possible product to match the extra storage size.



BREATHERS

All tanks sold through New Era tanks have allowance for breathers. Either through vented caps, or through 90 degree plastic fittings. It is imperative that fuel tanks have facility to properly breathe.

Live Bait Tanks

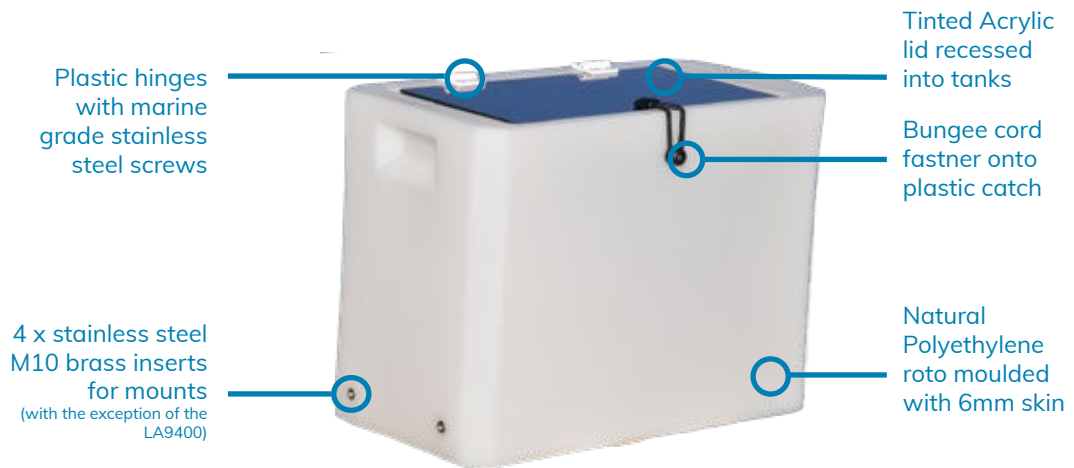

LA9000
35 Litre
This tank includes moulded internal handles.
Height: 350mm Depth: 260mm Width: 485mm

LA9200
55 Litre
Height: 370mm Depth: 300mm Width: 610mm

LA9400
65 Litre
This tank does not include stainless steel inserts for mounts
Height: 365mm Depth: 405mm Width: 405mm



LA9600
85 Litre
Height: 530mm Depth: 300mm Width: 605mm

LA9750
100 Litre
This tank includes a 3/4" brass female thread for drainage.
Height: 360mm Depth: 645mm Width: 490mm

Berley Buckets

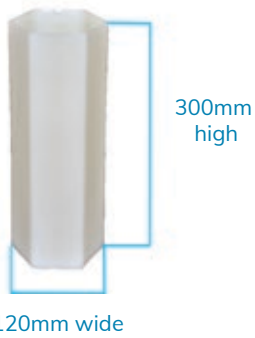

LA9520

Short Transom Berley Bucket

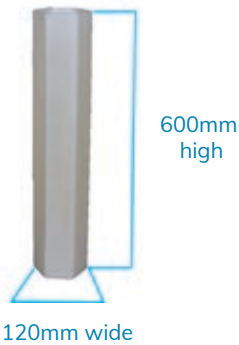

LA9522

Long Transom Berley Bucket

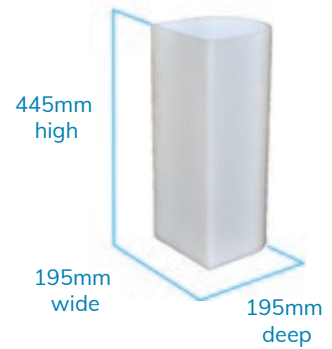

LA9525

D-Shaped Fixed Berley Bucket

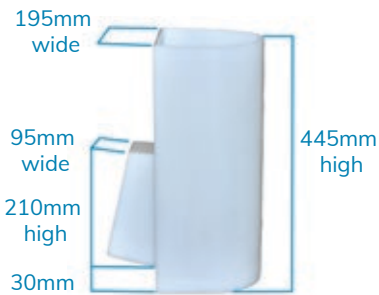

LA9530

D-Shaped Removable Berley Bucket with bracket



Stainless Steel Bracket for removable buckets

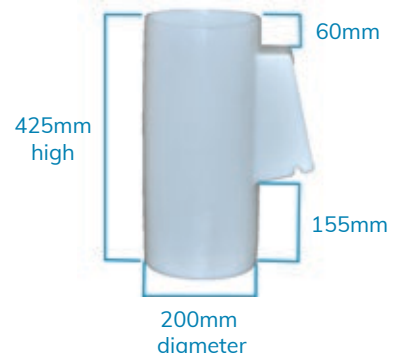

LA9534

Large Round Removable Berley Bucket with bracket



LA9540

Short Marlin Berley Bucket

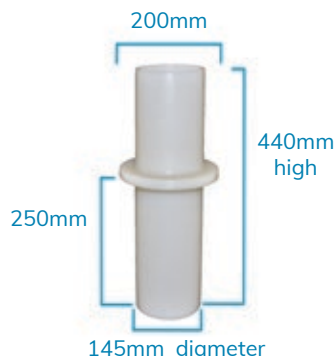

LA9542

Long Marlin Berley Bucket

10 PROTECTIVE CLOTHING

- > Aprons
- > Headwear
- > Eyewear
- > Gloves
- > Boots and Gumboots
- > Waders
- > Wet Weathers
- > Waterproof Gear Bag













In the challenging and unpredictable environments of our oceans, it's crucial to have Personal Protective Equipment (PPE) that ensures your safety while enabling freedom of movement for work and fishing activities.

Our selection of high-quality PPE is designed to safeguard you, allowing you to focus on your expertise without worrying about your protection.



















APRONS

Aprons are designed for use as fish industry workwear and for commercial use, such as for cleaning and preparing food. Many saltwater fishermen use the apron for preparing their catch.

					
PRT260	PRT240	PRT241	PRT252 - PRT253	PRT315	
Hepworths Platilon Apron	Hepworths Platilon Apron	Hepworths Platilon Apron	Polyester, Extra Tough, PVC Apron Tapes	Stormline Apron with Elastic Braces	
COLOUR: Red	COLOUR: Blue	COLOUR: White	COLOUR: Blue & White	COLOUR: Navy	
					
PL0128	PL0129	PL2548			
A-F2/TAPE PVC Reinforced Front Apron	A-F1/TAPE PVC with Brass Eyelets Apron	Short A-F4/TAPE PVC Apron			
COLOUR: White or Blue	COLOUR: White or Black	COLOUR: White			
HEADWEAR					
			GCH517	GCH505	GCH127
			Seamaster Cap	Seamaster Beanie	Balaklava

EYEWEAR

Ensure you keep your eyes protected with glasses from Seamaster. Clear and tinted safety glasses for general use and a great range of quality sunglasses from Ugly Fish and Askhuey. Ugly Fish Indestructables are perfect for the everyday bloke who tends to be a little rough with their sunnies. The TPEE frame is a rubber like material that is extremely flexible and lightweight making them virtually unbreakable. Polarised indestructables provide maximum UV protection and are super comfortable to wear all day long.

					
SFT004	SFT003	PRT169	PRT169	PRT169	PRT169
Frontier Vision X Safety Glasses Smoke	Frontier Vision X Safety Glasses Clear	Ugly Fish Matt Black Frame, Smoke Polarised Sunglasses	Ugly Fish Matt Black Frame, Brown Polarised Sunglasses	Ugly Fish Shiny Black Frame, Smoke Polarised Sunglasses	Ugly Fish Shiny Black Frame, Brown Polarised Sunglasses
					
PRT169	PRT169	PRT344	PRT347	PRT346	PRT345
Ugly Fish Black Frame, Smoke Polarised Sunglasses	Ugly Fish Black Frame, Brown Polarised Sunglasses	Ugly Fish Matt Black Frame, Smoke Polarised Bifocal 1.5, 2.0 or 2.5 Sunglasses	Ugly Fish Black Frame, Smoke Polarised Wraparound Sunglasses	Floating Sports Strap Red or Black	Neoprene Sports Strap Long or Short
					
PRT345	PL2066	PL2067	PL2068	PL0221	PL0223
Adjustable Sports Strap	Sunglasses Strap Askhuey Neoprene Black	Sunglasses Polarised Askhuey	Sunglasses Rapid Pro with 3 sets of Interchangeable Lenses	Binoculars 7x50 Auto Focus Standard Black	Binoculars 7x50 Plastimo Waterproof Blue/Black
					
PL2550					
Binoculars 15x70 Acuter Skylander Black					

GLOVES

Suppliers of a range of quality gloves. Seamaster has sourced these gloves keeping in mind the rugged conditions they will be used in, and the dexterity and protection essential for the long working days. Offering quality solutions for protection against the elements.

Some of the terms used to describe gloves include a cut rating, out of 5, with 5 being the highest.

LYNN RIVER

A heavy-duty rubber glove which has excellent wet or dry grip and offers excellent resistance to abrasion and tears. The cotton liner provides a comfortable fit.



PRT221

Lynn River Orange
Gloves 62060

SIZE: 7 - 10

FRONTIER

Orange Ruffy Glove

Orange latex crinkle cut grip finish with 100% cotton interlock lined for comfort and insulation from heat and cold.



PRT026

Frontier Orange
Ruffy

SIZE: M - XL

Splendor Winter Lined Glove

Roughened latex coating for excellent wet and dry grip. Excellent abrasion and puncture resistance with seamless polyester cotton with terry brushed liner for added warmth.



PRT172

Frontier Splendor
Winter
Cut Level 2

SIZE: 8 - 10

ANSELL

Hycare

Roughened latex coating for excellent wet and dry grip. Excellent abrasion and puncture resistance with seamless polyester cotton with terry brushed liner for added warmth.



PRT023

Ansell Hycare
Cotton Lined Rubber
Glove Cut Level 2

SIZE: 7 - 10

Gladiator

An ergonomical designed glove with natural rubber coating on an interlock liner.



PRT017

Ansell Alphatec
Gladiator
Green Gloves

SIZE: 7 - 10

ANSELL

Premium

Premium natural rubber glove with superior performance and durability.



PL0891

Ansell Alphatec
Premium Pink Gloves

SIZE: 8 - 10

Chemi-Pro

Bi-colour double dipped natural rubber & neoprene with flocked lining.



PL0864

Ansell Alphatec
Chemi Pro Gloves

SIZE: 8 - 10

BASTION

Modina

Seamless breathable knitted high visibility acrylic loop shell for level 2 contact cold resistance as low as -30°C . Cut level 3 protection. Sandy latex coating provides good flexibility, dexterity and oil resistance. Elastic knitted cuffs for comfortable secure fit.



PRT273

Bastion Modina Cut
Level 3

SIZE: 8 - 10

Cut 5 Liner Glove

HPPE/Glass fibre cut level 5 liner glove with excellent dexterity and feel. Lightweight and uncoated featuring elastic knitted cuffs for comfortable secure fit and is washable and reusable.



PRT276

Bastion Modina Cut
Level 5 Glove Liner

SIZE: 8 - 10

Soroca Hi-Viz

Seamless breathable high visibility HPPE/glass fibre cut level 5 shell with ergonomic design to ensure reduced hand fatigue. Double layer shell for superior feel and comfort and is oil resistant with breathable micro foam nitrile providing superior flexibility and dexterity over most cut level 5 gloves. All material is breathable.



PRT267

Bastion Soroca Hi-
Viz Green

SIZE: 8 - 10

Cottonlined Rubber Rough Grip

Natural rubber latex with rough granular finish for ultimate wet and dry grip. 1.2mm thickness for exceptional strength and puncture resistance. Cottonlined for superior comfort, perspiration absorption and cold resistance



PRT281

Bastion Cottonlined
Rubber Rough Grip

SIZE: 9 - 10

NINJA GLOVES

Seamless 15 gauge nylon shell for second skin sensitivity. Feather-light black polyurethane coating conceals dirt/grime and provides excellent grip in wet, dry and light oil applications.

					
PRT175 - PRT178	PL0889	PL0888			
Ninja P4001HPT.S	Ninja Gloves	Ninja Ice Gloves			
SIZE: 7-10	SIZE: S- 2XL	SIZE: S - 2XL			

OTHER

					
PRT011	SFT015	PL4258	PL0872	PL0894	PL0896
Cotton Glove	Red PVC Single Dip Gloves	3M Thinsulate Freezer Gloves	Shogun Red Cotton Gloves 12 pack	Shogun Red Cotton Gloves 12 pack	Shogun White Cotton Gloves 12 pack
SIZE: 10	SIZE: 10	SIZE: S - 2XL			
					
PL0862	PL3471	PL0893	PL0892	PL4257	PL2939
Blue Nitrile Gloves	Red PVC Chemical Gloves 27cm	Red PVC Chemical Gloves 45cm	Green PVC Chemical Gloves 27cm	3M Arm Guard Protector	Guy Cotton Arm Guard Protector
SIZE: 8 - 10					

BOOTS AND GUMBOOTS

Mack “FORCE” Safety Boots

The Mack “FORCE” Zip Boot is ideal for workers exposed to, or working around water as well as those who are required to remove their footwear multiple times a day.

Features



- > Steel toecap
- > Slip resistant sole
- > Heat resistant sole up to 150 degrees
- > Oil and fuel resistant sole
- > Anti-static
- > Water shedding material
- > Scuff cup
- > Approved to AS/NZS 2210.3 (Class I S1 SRC)



PRODUCT CODE	SIZE	COLOUR
PRT397	UK 8	Honey
PRT398	UK 9	Honey
PRT399	UK 10	Honey
PRT400	UK 11	Honey
PRT401	UK 12	Honey
PRT402	UK 13	Honey

Recreational Boots

Warm, Comfortable and Sole Grip to suit your application, Burke Seaboots are perfect for sailing and Fly N Dry Neoprene boots will keep you dry and warm.

					
PRT361	PRT283	PRT342			
Burke Seaboots with cut sole	Fly N Dry Neoprene Boots	Fly N Dry Launching Boots			

Bekina StepLiteX Safety Toe

Made from flexible NEOTANE – a high quality polyurethane and are a wide fit to ensure user-comfort. Resistant to oils, fats, blood and chemical cleaning products. These boots are light yet strong and have a high thermal insulation.



STYLE	8	9	10	11	12	13	14
BEKINA STEPLITEX	PRT384	PRT385	PRT386	PRT387	PRT388	PRT389	PRT390

Dunlop Purofort

Lightweight for minimising foot fatigue, SRC rated (slip resistant) outsole for excellent grip and high traction on uneven surfaces for maximum safety.



PRT079

Dunlop Purofort Safety Toe

SIZE: 6-13

PRT078

Dunlop Purofort Non-Safety Toe

SIZE: 6-13

Maxisafe 'Shova' PVC Gumboot

Lightweight, general purpose PVC gumboot manufactured from virgin PVC material. Resistant to oils, acids, fats and other animal by-products.



STYLE	8	9	10	11	12	13
MAXISAFE SHOVA	FWG905-08	FWG905-09	FWG905-10	FWG905-11	FWG905-12	FWG905-13

WADERS

We stock both neoprene and shell style waders to suit any application. Both styles of waders have been developed in South Australia and the success of these designs come as a result of many years of trial and error. Made from premium materials, these waders will keep you dry and let you get on with the reason you are standing in a puddle in the first place.



PRODUCT CODE	STYLE	SIZE
PRT242	Aussie Oyster Wear	7 - 13 S - 3XL



PRODUCT CODE	STYLE	SIZE
PRT308	Fly 'n Dry Neoprene Waders (Blundstone Boot)	6 - 13



PRODUCT CODE	STYLE	SIZE
PRT070	Tuffwear Full Length Waders	8 - 12



PRODUCT CODE	STYLE	SIZE
PRT309	Fly 'n Dry Neoprene Waders (Hardsole Boot)	6 - 13



PRODUCT CODE	STYLE	SIZE
PL4550	Elka Waders (Dunlop Boot)	UK 7 - 12



PRODUCT CODE	STYLE	SIZE
PRT107	Budget PVC Chest Waders	9 - 12



PRODUCT CODE	STYLE	SIZE
PL2442	Horne's Pimple Sole Waders	6 - 12



PRODUCT CODE	STYLE	SIZE
PRT111	Budget Neoprene Waders	9 - 13



PRODUCT CODE	STYLE	SIZE
PL2441	Horne's Oyster Waders	6 - 12



PRODUCT CODE	STYLE	SIZE
PRT209	Kaiwaka Tufflon Wader Covers	5 - 3XL

WET WEATHERS

Seamaster is a distributor of Stormline, Kiawaka and Horne's Aqua wet weather gear. Ranging from heavy duty material for heavy duty work, through to super comfortable light weight trousers and jackets in breathable, stretch fabric.

We recommend that you always wear an approved life jacket, where applicable.

STORMLINE

Stormline Milford

The Milford 649 foul weather fishing pants is a unisex design with a high back, elasticated waist and adjustable side gusset on larger sizes for comfort and durability. The 649 includes knee pads as standard and a reinforced 2-layer 630 gsm PVC front. A highly comfortable bib and brace designed for all conditions.

The Milford 249 foul weather fishing jacket is built for comfort and durability. Made with 630 gsm PVC, the jacket is designed to be comfortable and to withstand the harshest environments. The jacket is also a unisex design. The grey/neon colours are designed for safety and to look good as well!



PRODUCT CODE	STYLE	SIZE
PRT127	Milford 649 Bib	S - 3XL
PRT132	Milford 249 Jacket	S - 3XL

STORMLINE

Stormline Stormtex Air

Stormtex Air is a lightweight wet weather gear designed for commercial and recreational fishing, commercial users and agriculture. It is designed to be comfortable, with the 320 gsm PVC/PU being the perfect balance between weight and durability.



PRODUCT CODE	STYLE	SIZE
PRT143	Stormtex Air Bib 660	S - 3XL
PRT148	Stormtex Air 203 Jacket	S - 3XL

Flotation Bib

The Stormline fishing flotation pants have special closed cell foam in the knees and the front and back to provide additional safety, allowing the wearer assisted flotation in the water as a certified aide and designed for 50N of buoyancy. The cut of the floatation pants are designed so that you can keep working freely, with an adjustable waist and ventilation on either side.

These fishing flotation pants are popular for commercial fishermen working alone at sea, trawlers and for general safety for anyone working around water. This product is EN ISO 12402-5 certified and approved by Maritime New Zealand as a Type 403 and 405 inherently buoyant flotation device.



PRODUCT CODE	STYLE	SIZE
PRT257	Flotation Bib 662	S - 3XL

STORMLINE

Nelson

Combining lightweight material with robust design for the ultimate in on-the-job weather protection. Every technical detail you require has been engineered and designed into the Nelson 248 waterproof rain jacket and not a single gram of weight goes to waste.

Optimised and designed for weather protection in warmer climates, keeping you dry and cool without weighing you down. The Nelson 948 wet weather gear short sleeve jacket is built for comfort and engineered to last, handling all types of inclement weather with ease. The perfect choice for recreational fishing, marine work and sailing.

Designed with visibility, safety and ultimate comfort in mind, the Nelson 656 wet weather gear bib & brace is a highly technical solution for professionals who can't let the weather get in the way of their work. Triple-padded knees, premium grade 480gsm PVC and seamless trousers are just a handful of the features that make the 656 popular with commercial and leisure fishermen around the world.



PRODUCT CODE	STYLE	SIZE
PRT237	Nelson A248 Jacket FSLV	S - 3XL
PRT238	Nelson A948 Jacket 1/2 SLV	S - 3XL
PRT239	Nelson A656 Bib	S - 3XL

Commercial Fishing Sleeve

Oil and liquid resistant arm sleeves for harsh commercial conditions. Keep your arms, fishing gear and wet weather jackets protected, clean and dry whatever the task at hand.



PRODUCT CODE	STYLE	SIZE
PRT168	Commercial Fishing Sleeve	One Size

STORMLINE

Stormline Fishermans Vest 985 & 982TN

Designed for anyone working outdoors, this popular vest is a must-have for fishermen, builders, farmers and forestry workers. With a fleece lining and rear storm flap this oilskin vest will keep you warm and dry.



PRODUCT CODE	STYLE	SIZE
PRT139	Fishermans Vest 985	S - 3XL
PRT155	Fishermans Vest 982TN	S - 3XL

Atlantic 806 Pullover

Designed for warmth and durability, the Atlantic 806 fleece/PVC pullover has warm fleece with heavy duty 650gsm PVC to withstand the demands of commercial fishing. The PVC goes up to the shoulder for operating traps or other equipment. This pullover is great for warmth and is waterproof and durable where it counts. The pullover includes fleece lined sleeves for comfort and adjustable neoprene cuffs to help keep the water out.



PRODUCT CODE	STYLE	SIZE
PRT295	Atlantic Pullover	S - 3XL

KAIWAKA

Tufflon Bib and Jacket

Our Tufflon Fisherman's Bib Overtrousers are intensely durable, highly resistant to abrasions, incredible tear strength and 100% waterproof. The Fisherman's Parka is an ultra-durable, lightweight jacket and exceptionally resistant to abrasions and has amazing tear strength, not to mention it's also 100% waterproof and comfortable.



PRODUCT CODE	STYLE	SIZE
PRT203	Tufflon Fishermans Bib Overtrousers	S - 3XL
PRT198	Tufflon Parka	S - 3XL
PRT209	Tufflon Wader Covers	S - 3XL

Aquaseal Bib and Jacket

Specifically designed for extreme weather conditions the Aquaseal Parka is one of our most sought-after jackets. Made to withstand fish fats and oils, along with the wild weather, this durable and comfortable hi-vis jacket is everything you need.

Aquaseal Fishman's Bib Overtrousers are crafted for the express purpose of protection against the harshest fishing conditions while also being comfortable and resistant to fish fats and oils.



PRODUCT CODE	STYLE	SIZE
PRT186	Aquaseal Parka	S - 3XL
PRT192	Aquaseal Bib Overtrousers	S - 3XL

KAIWAKA

Stormforce TTMC-W

Stay safe, dry, and warm with total ease of movement, comfort, and breathability with KAIWAKA Stormforce TTMC-W jacket. Safety rated, and 100% wind and rain-proof, this premium twin-skin, high vis safety jacket is the ultimate protection on the work site, regardless of the weather.



PRODUCT CODE	STYLE	SIZE
PRT298	Stormforce TTMC-W	S - 3XL

Windtec

Offering streamlined design and unmatched windproof and waterproof performance, this wet weather gear has you covered with long-lasting comfort and coverage.



PRODUCT CODE	STYLE	SIZE
PRT215	Windtec Sleeveless Vest	S - 6XL
PL3402	Windtec Short Sleeve Vest	S - 6XL



PRODUCT CODE	STYLE	SIZE
PL1181	Windtec PVC Parka	S - 3XL
PL1187	Windtec PVC Overtrousers	S - 3XL
PL3393	Windtec PVC Bib Overtrousers	S - 3XL

KAIWAKA

Kaiwaka Weathershield

Built strong, to take you through the harshest conditions and toughest jobs, this high-end camo fleece is your go-to garment for working and playing outdoors. Great by itself or layered up. Supreme weatherproofing combined with microfleece comfort, designed, and engineered to perfection.



PRODUCT CODE	STYLE	SIZE
PRT350	Kaiwaka Weathershield Long Sleeve Hood Olive	S - 4XL
PRT351	Kaiwaka Weathershield Short Sleeve Hood Olive	S - 4XL
PRT352	Kaiwaka Weathershield Long Sleeve Hood Camo	S - 4XL

HORNE'S AQUA

The garments are designed for especially rugged conditions to protect you from wind and rain whilst providing ease of movement and extra comfort. All seams are High Frequency welded which provides strength, durability, and total waterproof protection.



PRODUCT CODE	STYLE	SIZE
PL2073	Marine Fresh Wet Weather Set	M - 2XL

BOURKE MARINE

Designed for harbour and light coastal use with features that will keep you dry and comfortable. Made from durable nylon-coated Superdry fabric and incorporating TSS technology and a breathable lining, Superdry Jackets and Trousers are 100% waterproof and super tough - but soft on the skin. That's why it is a favourite among yachties, fishermen and marine workers alike.



PRODUCT CODE	STYLE	SIZE
PRT409	Burke Marine Super Dry 3/4 Jacket Blue	XS - XL
PRT414	Burke Marine Super Dry Trousers Blue	XS - XL

ELKA

Due to the demand from Industrial markets, ELKA has developed a series of high-quality and certified work rainwear for optimum safety in the most exposed work areas. Developing the strongest waterproof workwear on the market, ELKA's quality assurance is the key to their premium product range for protection against the extremes.



PRODUCT CODE	STYLE	SIZE
PL4334	Elka Polar Fleece Jumper PVC Bib and Arms	XS - 5XL



PRODUCT CODE	STYLE	SIZE
PL4320	Elka Unlimited Bib & Brace	S - 6XL
PL4319	Elka Unlimited Jacket	S - 6XL



PRODUCT CODE	STYLE	SIZE
PL4318	Elka Xtreme Bib & Brace	S - 6XL
PL4317	Elka Xtreme Jacket	S - 6XL

TUFFMAR INTERNATIONAL

Australian made and owned wet weather gear for Australian conditions.

Warm Wear Jacket & Sleeveless Vest

Specifically designed for the commercial fishing industry. Featuring a waterproof PVC Galeforce outer shell and Fibrepile inner lining for warmth.



PRODUCT CODE	STYLE	SIZE
TF110	Warm Wear Jacket	S - 3XL
TF105	Warm Wear Vest	S - 3XL

WATERPROOF GEAR BAG



PRT419

Blue Marine Yachtsman Waterproof Gear Bag 70Ltr Yellow

PRT416

Blue Marine Yachtsman Waterproof Gear Bag 40Ltr Blue

PRT463

Blue Marine Yachtsman Waterproof Gear Bag 70Ltr Black

PRT417

Blue Marine Yachtsman Waterproof Gear Bag 60Ltr Black

12 ROPE & CORDAGE

- > 3 Strand
- > 8 Strand
- > 12 Strand
- > Lead Core
- > Braid
- > Twine
- > Working Tools

Seamaster has earned a reputation for supplying top quality rope and cordage across the spectrum of marine, aquaculture and commercial fishing applications.

With materials ranging from polypropylene and polyolefin, to dyneema and nylon, Seamaster can provide rope, braids, and cordage to suit your needs. Sizes from 1mm in netting twine right up to 100mm 8 strand mooring lines.

Seamaster offers high quality ropes for use in many applications. From commercial fishing and mooring, to shipping and general purpose. Our ropes are UV treated to cope with the harsh environment and have been developed directly in consultation with our manufacturers and customers and selected to ensure value, quality and consistency.

Offered in coils usually at 250m, most rope can be cut to length or ordered in a length that suits your application.

3 STRAND

Duradan Candy

Made from a 50/50 blend of Duradan Silver and Duradan Mono yarns, is a high strength, abrasive resistant, medium/hard lay rope specifically for the cray fishing industry. The term Candy comes from its 'candy bar' type appearance.

PRODUCT CODE	DIAMETER (MM)	COIL LENGTH (M)	BREAK STRENGTH (KG)
ROP404	10	220	1,900
ROP401	12	220	2,600



SuperTec

Our premium product, offering superior strength for size and abrasion resistance for diameter. In essence, a smaller rope can be used to achieve an equivalent break strain requirement. SuperTec is easy to handle, floats and does not absorb water. All SuperTec 3 strand rope is medium lay.



PRODUCT CODE	DIAMETER (MM)	COIL LENGTH (M)	BREAK STRENGTH (KG)
ROP230	4	250	
ROP209	5	250	
ROP128	6	250	850
ROP216	7	250	
ROP129	8	250	1,450
ROP130	9	250	1,830
ROP131	10	250	2,190
ROP132	12	250	3,200

PRODUCT CODE	DIAMETER (MM)	COIL LENGTH (M)	BREAK STRENGTH (KG)
ROP134	14	250	4,250
ROP135	16	250	5,400
ROP137	18	250	6,900
ROP138	20	250	8,200
ROP139	24	250	11,800
ROP141	28	250	15,600
ROP142	32	250	19,600
ROP147	40	250	29,600

SuperDan

A supplement range to the SuperTec line, SuperDan is an economical yet long lasting rope that is tough and provides low friction over multiple surfaces. Life span of this rope is generally 10% greater than that of a standard PP rope. SuperDan will float in water, does not lose strength when wet and has good UV resistance.



PRODUCT CODE	DIAMETER (MM)	COIL LENGTH (M)	BREAK STRENGTH (KG)	LAY
PL3588 - WHITE	4	250		
ROP198 GREY / BLUE	6	500	680	Medium
ROP391 - BLUE ROP392 - YELLOW ROP393 - RED	9	250	1,360	Medium
ROP089 - BLACK	9	250	1,360	Hard
ROP394 - BLUE ROP395 - YELLOW ROP396 - RED	10	250	1,600	Medium
ROP398 - BLUE ROP093 - BLACK	12	250	2,250	Medium / Hard
ROP400 ROP095 - BLACK	14	250	3,000	Medium
ROP399 - BLUE	14	250	3,000	Medium / Hard
ROP102 - BLACK	20	250	5,600	
ROP105 - BLACK	24	250	8,100	Medium / Hard



Powermixed

Specifically selected for the cray fish industry for its durability and strength. Constructed from a blend of polyolefin and polyester, Powermixed has a neutral – negative buoyancy with excellent wearing properties.



PRODUCT CODE	DIAMETER (MM)	COIL LENGTH (M)	BREAK STRENGTH (KG)
ROP384	6	500	900
ROP571	7	500	1,250
ROP572	8	125	1,600
ROP573	9	125	2,000
ROP353	9	250	2,000
ROP574	10	125	2,400
ROP383	10	250	2,400
ROP575	12	125	3,400
ROP382	12	250	3,400
ROP374	14	250	4,700



PE Silver

Usually identified as “Silver” rope, offering great handling, floating rope with excellent UV properties. A very good general-purpose rope. All PE Silver 3 strand rope is medium lay.



PRODUCT CODE	DIAMETER (MM)	COIL LENGTH (M)	BREAK STRENGTH (KG)
ROP054	6	125	370
ROP055	6	250	370
ROP056	8	125	620
ROP057	8	250	620
ROP058	9	250	770
ROP059	10	125	940
ROP060	10	250	940
ROP061	12	125	1,260
ROP062	12	250	1,260

PRODUCT CODE	DIAMETER (MM)	COIL LENGTH (M)	BREAK STRENGTH (KG)
ROP063	14	250	1,440
ROP064	16	250	2,120
ROP065	18	250	2,590
ROP066	20	250	3,160
ROP067	24	250	4,390
ROP068	28	250	5,490
ROP069	32	250	7,770
ROP070	40	250	12,130

Powertwist

Polyethylene Silver 3 strand Rope.



PRODUCT CODE	DIAMETER (MM)	COIL LENGTH (M)	BREAK STRENGTH (KG)
PL3643	8	220	1,100
PL1730	10	220	1,600
PL1732	12	220	2,200
PL1734	14	220	3,100
PL1737	16	220	3,800
PL1739	18	220	7,000
PL1740	20	220	8,100
PL1741	22	220	7,000
PL1742	24	220	8,100
PL1743	32	220	13,500



Hard-Lay Aquatec

Donaghy's legendary Aquatec formula in a tighter lay made exclusively for Seamaster. The tighter lay provides higher abrasive resistance.

PRODUCT CODE	DIAMETER (MM)	COIL LENGTH (M)	BREAK STRENGTH (KG)
ROP430	8	250	1,200
ROP425	9	250	1,500
ROP426	10	250	1,800
ROP427	12	250	2,700
ROP428	16	250	4,500



Polyester Tarred 3-strand Longline Rope

PRODUCT CODE	DIAMETER (MM)	COIL LENGTH (M)	COLOUR
PL1789	3	1,000	Black
PL1788	5	500	Black
PL1790	7	500	Black



Magni Polysteel

Manufactured from 100% High Tenacity Polypropylene, Magni Polysteel has an MBL approximately 30% higher than conventional PP ropes. With a UV Stabilisation of 3%, this rope is a great all-rounder.



PRODUCT CODE	DIAMETER (MM)	COIL LENGTH (M)	BREAK STRENGTH (KG)
ROP415 - GREEN	7	250	700
ROP417 - GREEN ROP418 - ORANGE	8	250	1,350
ROP406 - YELLOW ROP420 - GREEN	9	250	2,000
ROP407 - YELLOW ROP421 - GREEN	10	250	3,000
ROP409 - YELLOW ROP422 - GREEN	12	250	2,840
ROP411 - YELLOW	14	250	3,910
ROP412 - YELLOW	16	250	4,900
ROP413 - YELLOW	20	250	7,520



Powerdan

Made from high quality polyolefin fibre. This rope offers great tenacity and high strength.



PRODUCT CODE	DIAMETER (MM)	COIL LENGTH (M)	BREAK STRENGTH (KG)
PL1775	4	500	300
ROP264	6	250	700
ROP265 - GREEN	8	250	1,300
ROP266	10	250	1,800
ROP267	12	250	2,600
ROP268	14	250	3,600
ROP269	16	250	4,500

PRODUCT CODE	DIAMETER (MM)	COIL LENGTH (M)	BREAK STRENGTH (KG)
ROP270	18	250	5,700
ROP271 GREEN / YELLOW	20	250	6,800
ROP534	22	250	8,200
ROP272	24	250	9,600
ROP255	28	250	12,600
ROP273	32	250	16,000

8 STRAND

Seamaster stocks a range of 8 strand ropes, ideal for mooring and towing applications. We hold standard shipping lines in 220m lengths with soft eyes and eye covers at each end, in 56mm, 64mm and 72mm diameter. Please enquire for specific lengths, in house splicing and other available sizes.

Powertex



PRODUCT CODE	DIAMETER (MM)	COIL LENGTH (M)	BREAK STRENGTH (KG)
ROP317	28	250	17,400
ROP507	32	250	22,700
ROP371	38	250	31,800
ROP293	44	250	41,700
ROP519	50	250	52,200
ROP296	56	250	65,000
ROP508	64	250	84,000
ROP516	72	250	106,000
ROP518	85	250	146,000
ROP517	100	250	200,000



Powerdan



Made from high quality polyolefin fibre, this rope offers great tenacity and high strength.



PRODUCT CODE	DIAMETER (MM)	COIL LENGTH (M)	BREAK STRENGTH (KG)
ROP389	22	220	8,200
ROP253	32	220	17,600
ROP274 BLACK + YELLOW	32	250	
ROP529	36	250	22,100

PRODUCT CODE	DIAMETER (MM)	COIL LENGTH (M)	BREAK STRENGTH (KG)
ROP254	40	220	27,500
ROP530	40	250	27,500
ROP531	48	250	38,100
ROP258	52	220	45,200
ROP333	64	220	65,000

PowerTex



PRODUCT CODE	DIAMETER (MM)	COIL LENGTH (M)	COLOUR
ROP532	28	220	White
ROP533	32	220	White

SuperTec

Our premium product offering superior strength for size and abrasion resistance. In essence, a smaller rope can be used to achieve an equivalent break strain requirement. SuperTec is easy to handle, floats and does not absorb water.

PRODUCT CODE	DIAMETER (MM)	COIL LENGTH (M)	BREAK STRENGTH (KG)
ROP140	24	250	13,400
ROP143	32	250	22,700
ROP149	44	250	38,000
ROP009	50	250	52,200
ROP010	56	250	62,600
ROP242	72	250	101,100



SuperDan

PRODUCT CODE	DIAMETER (MM)	COIL LENGTH (M)	BREAK STRENGTH (KG)
ROP170	32	220	16,800
ROP007	40	220	25,700
ROP108	48	220	36,600
ROP164	56	220	48,700
ROP165	64	220	62,500
PL1752	64	120	
ROP110	72	220	77,900



12 STRAND

Powerdan



High tenacity polyprop 12 strand rope.

PRODUCT CODE	DIAMETER (MM)	COIL LENGTH (M)	BREAK STRENGTH (KG)	COLOUR	LAY
ROP096	14	250	3,600	Grey/Red	Medium
ROP097	14	250	3,600	Yellow/Black	Medium
ROP346	16	250	4,500	Sea Green	Medium
ROP313	20	250	6,800	Sea Green	Medium/Soft



LEAD CORE

Powerlead

Our 3-Strand Lead Core range. Made from the same material used in our Powerdan range with a choice for either lead wire or beads to add weight where a sinking rope is required for applications like gill nets or long lines.

PRODUCT CODE	DIAMETER (MM)	COIL LENGTH (M)	WEIGHT (GMS/METRE)
ROP205	7	250	40
ROP309	7	250	60
ROP310	9	200	200
ROP311	12	110	220
ROP312	14	200	400



BRAID

Polyester Bowline Double Braid Rope

100% Polyester core & cover rope manufactured in Australia. Designed with optimal strength and density to provide long life and consistent performance. Easy to use, multiple applications and good UV resistance.

PRODUCT CODE	DIAMETER (MM)	COIL LENGTH (M)	COLOUR
RPB169	4	100	Solid Black
RPB131	6	200	Solid Black
RPB025	8	200	Solid Black
RPB049	10	200	Solid Black
RPB128	12	100	Solid Black
RPB129	14	100	Solid Black
RPB116	16	100	Solid Black
RPB184	20	100	Solid Black



Polyester 8-Plait VB Cord

100% polyester core and cover – 8-plait construction. General purpose cord for lacing and lashing. Flexible, versatile and good UV and chemical resistance. **Available in white only.**

PRODUCT CODE	DIAMETER (MM)	COIL LENGTH (M)
RPC109	2	100
RPC110	2	500
RPC111	3	100
RPC112	3	500
RPC113	4	100
RPC114	4	500
RPC115	5	100
RPC116	5	500
RPC117	6	100
RPC118	6	500



Falcon Braid with Urethane Impregnated Core

100% UHMWPE (Urethane Impregnated) core and 100% Polyester cover. Light yet strong with very low stretch and excellent UV and water resistance. Manufactured in Australia.

PRODUCT CODE	DIAMETER (MM)	COIL LENGTH (M)	COLOUR
RPB132	2	100	Red
RPB133	2	100	Green
RPB134	2	100	Blue
RPB135	2	100	Yellow
RPB136	3	100	Red
RPB137	3	100	Blue
RPB138	3	100	Green
RPB139	3	100	Yellow
RPB140	4	100	Red
RPB141	4	100	Blue
RPB142	4	100	Green
RPB143	4	100	Yellow
RPB144	5	100	Red
RPB145	5	100	Blue
RPB146	5	100	Green
RPB147	5	100	Yellow



Double 16 Braided Polyester

PRODUCT CODE	DIAMETER (MM)	COIL LENGTH (M)	COLOUR
PL1719	4	500	White + Yellow
PL1728	6	200	White + Blue
PL1729	8	200	White + Red
PL1720	10	200	White
PL1722	12	200	White + Blue
PL1724	14	100	White + Yellow
PL1726	16	100	White + Black
RPB112	18	100	White + Black



TWINE



PRODUCT CODE	DESCRIPTION	COLOUR
RPC082	Twine Braided Nylon White, 16 Braids, 1.0mm x 1kg	White
RPC084	Twine Braided Nylon White, 16 Braids, 1.5mm x 1kg	White
RPC086	Twine Braided Nylon White, 16 Braids, 2.0mm x 1kg	White
RPC088	Twine Braided Nylon White, 16 Braids, 2.5mm x 1kg	White
RPC090	Twine Braided Nylon White, 16 Braids, 3.0mm x 1kg	White
RPC092	Twine Braided Nylon White, 16 Braids, 4.0mm x 1kg	White
PL2379	Twine Braided Nylon White, 16 Braids, 5.0mm x 1kg	White

PRODUCT CODE	DESCRIPTION	COLOUR
RPC081	Twine Braided Nylon Tarred, 16 Braids, 1.0mm x 1kg	Black
RPC083	Twine Braided Nylon Tarred, 16 Braids, 1.5mm x 1kg	Black
RPC085	Twine Braided Nylon Tarred, 16 Braids, 2.0mm x 1kg	Black
RPC087	Twine Braided Nylon Tarred, 16 Braids, 2.5mm x 1kg	Black
RPC089	Twine Braided Nylon Tarred, 16 Braids, 3.0mm x 1kg	Black
RPC091	Twine Braided Nylon Tarred, 16 Braids, 4.0mm x 1kg	Black
PL2371	Twine Braided Nylon Tarred, 16 Braids, 5.0mm x 1kg	Black
PL2372	Twine Braided Nylon Tarred, 16 Braids, 7.0mm x 1kg	Black



PRODUCT CODE	DESCRIPTION	COLOUR
PL2381	Twine Euroflex Soft Polyblend 3.0mm x 2kg	Green + White
PL2382	Twine Euroflex Soft Polyblend 4.0mm x 2kg	Green + White
PL2383	Twine Euroflex Soft Polyblend 5.0mm x 2kg	Green + White
PL4277	Twine Euroflex Soft Polyblend 10mm x 7kg	Green + White



PRODUCT CODE	DESCRIPTION	COLOUR
PL2560	Twine Euroline Flat PE 3.0mm x 2kg Spool	Green
PL2384	Twine Euroline Flat PE 4.0mm x 2kg Spool	Green
PL2385	Twine Euroline Flat PE 5.0mm x 2kg Spool	Green
PL2386	Twine Euroline Flat PE 6.0mm x 2kg Spool	Green



PRODUCT CODE	DESCRIPTION	COLOUR
PL2390	Twine PE Mending .40mm/12 x 1kg	Orange
PL2391	Twine PE Mending .40mm/21 x 1kg	Orange



PRODUCT CODE	DESCRIPTION	COLOUR
PL2392	Twine Solid Euroline 2.5mm x 2kg Spool	Green + Yellow
PL2393	Twine Solid Euroline 3.0mm x 2kg Spool	Green + Yellow
RPC099	Twine Solid Euroline 4.0mm x 2kg Spool	Green + Yellow
PL2394	Twine Solid Euroline 5.0mm x 2kg Spool	Green + Yellow



PRODUCT CODE	DESCRIPTION	COLOUR
PL2395	Twine Solid Euroline Gold 1.3mm x 2kg Spool	Green + Gold
PL2396	Twine Solid Euroline Gold 1.8mm x 2kg Spool	Green + Gold



PRODUCT CODE	DESCRIPTION	COLOUR
PL2387	Twine Kuralon 20/60ply 1kg Spool	White



PRODUCT CODE	DESCRIPTION	COLOUR
PL2388	Twine Nylon 210d/12 x 250g	Brown or White



PRODUCT CODE	DESCRIPTION	COLOUR
PL2364	Twine 8 Braided Polyester with Core 2.5mm x 1kg	Blue



PRODUCT CODE	DESCRIPTION	COLOUR
PL3850	Twine PE 400/36 Black 500g Cobb	Black
PL3968	Twine PE 400/48 Black 1kg Spool	Black
PL4225	Twine PE 400/48 Black 500g Spool	Black



PRODUCT CODE	DESCRIPTION	COLOUR
RPC017	Twine Nylon Black 210d 15 X 500	Black
RPC018	Twine Nylon Black 210d 24 X 500	Black
RPC019	Twine Nylon Black 210d 36 X 500	Black
RPC020	Twine Nylon Black 210d 48 X 500	Black
RPC021	Twine Nylon Black 210d 64 X 500	Black



PRODUCT CODE	DESCRIPTION	COLOUR
RPC022	Twine Nylon White 210d 15 X 500	White
RPC023	Twine Nylon White 210d 24 X 500	White
RPC024	Twine Nylon White 210d 36 X 500	White
RPC025	Twine Nylon White 210d 48 X 500	White
RPC026	Twine Nylon White 210d 64 X 500	White



PRODUCT CODE	DESCRIPTION	COLOUR
RPC077	Snooding PE Solid Braid 3mm Rope	Orange



PRODUCT CODE	DESCRIPTION	COLOUR
RPC076	Snooding PE Solid Braid 3mm Rope	Green

WORKING TOOLS

Net Needles

Our range of net needles are stocked in a variety of different sizes from small needles of 6.5x110 for light net work right through to larger 33x310 needles for bigger purse seine nets. Supplied in the Norwegian H type (prong end) or the flat eye and tongue style.

NORWEGIAN H TYPE		
PRODUCT CODE	WIDTH (MM)	LENGTH (MM)
PL1516	6.5	110
NET019	6.5	130
PL1503	8.5	130
PL1520	10	110
PL1510	10	170
NET020	10	200
NET022	14	200
PL2554	16	240
NET024	20	175
NET025	20	250
NET026	27	200
PL1513	27	250
PL1521	32	250
NET029	33	310



FLAT EYE AND TONGUE		
PRODUCT CODE	WIDTH (MM)	LENGTH (MM)
PL1504	7.5	150
NET021	12	130
PL1505	17	172
PL1501	20	170
PL1507	23	200
PL1508	34	250

Rope and Steel Splicing Tools

Seamaster, a leading provider in the maritime industry, offers a comprehensive range of high-quality rope and steel splicing tools tailored to meet the diverse needs of professionals working with different strand sizes. With a strong focus on innovation and precision, Seamaster offers a line of cutting-edge splicing tools that guarantee efficiency, durability, and safety in every operation.



• Steel Splicing Tool

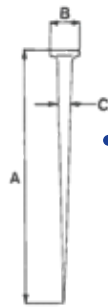

• Steel Splicing Tool

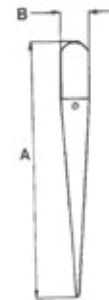

• Rope Splicing Tool (FIDS)

PRODUCT CODE	DESCRIPTION	HANDLE	A (MM)	B (MM)	C (MM)
NET015	Rope Splicing FID Stainless Steel	Nylon	170	24	
NET045	Rope Splicing FID Stainless Steel	Nylon	170		
NET016	Rope Splicing FID Stainless Steel	Wood	280	32	
NET017	Rope Splicing FID Stainless Steel	Nylon	305	33	
NET018	Rope Splicing FID Stainless Steel	Nylon	385	43	
NET062	4 FIDs will splice double braid from 4mm to 12mm and 3 strand to 20mm	Stainless Steel		4, 5.5, 7.5, 10	
PL1451	Steel Splicing	Chrome Steel Hardened Tip	310	28	20
NET087	Steel Splicing	Chrome Steel Hardened Tip	350	38	25

12 SAFETY

- > General Safety Equipment
- > Flares
- > Life Jackets
- > Hydrostatic Release Units for Life Rafts

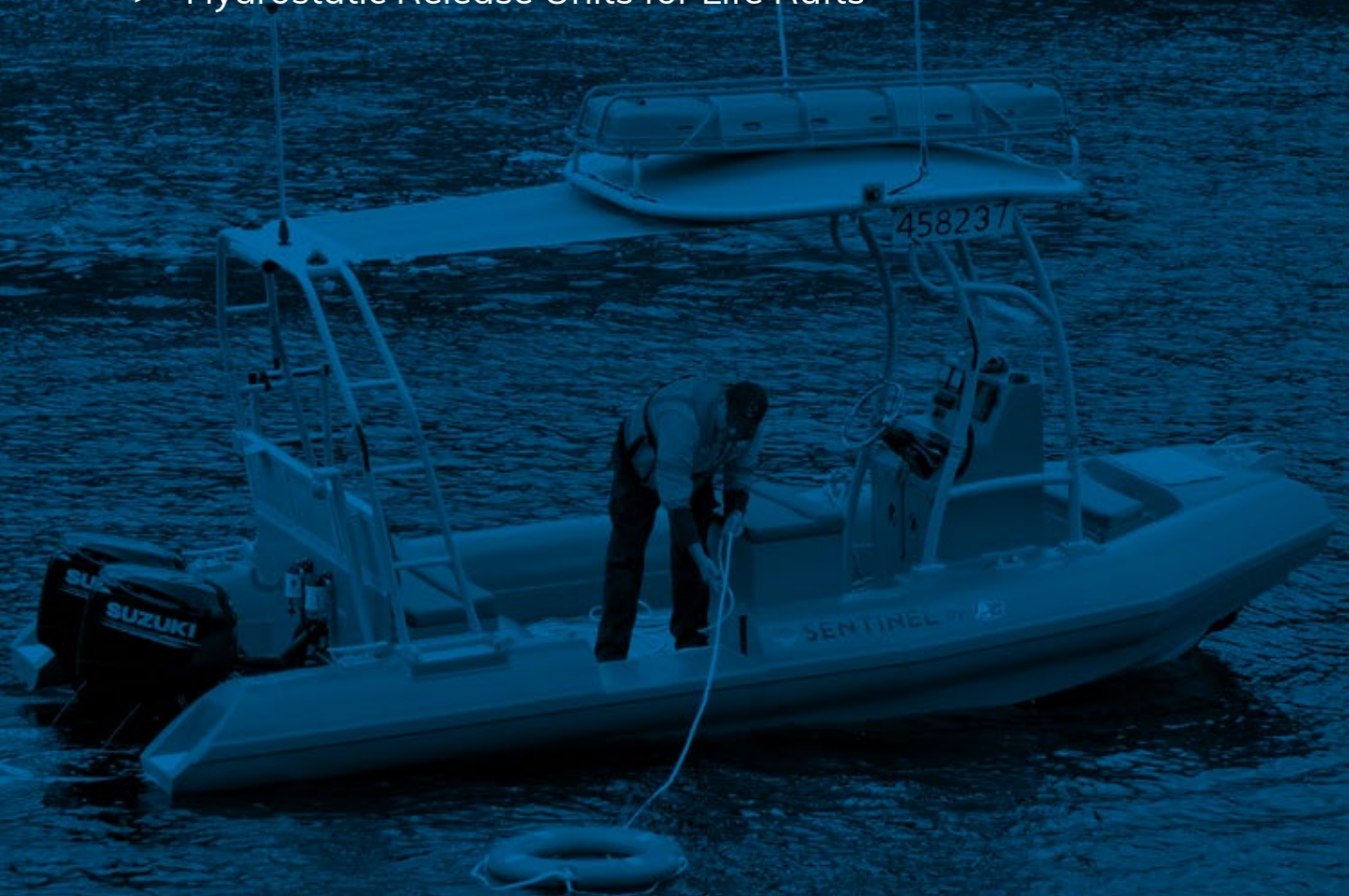













Seamaster is committed to ensuring safety comes first in the marine, aquaculture, and fishing industries. Our products help keep you safe and reduce the risk of maritime-related hazards.

We offer an array of durable easy-use personal safety products designed to withstand the harshest environments.

GENERAL SAFETY EQUIPMENT

We can supply all marine safety equipment whether it is a survey requirement to keep your crew safe on board a commercial vessel or you and your family while enjoying recreational boating.

					
SFT037	SFT050	SFT080	SFT065	SFT081	SFT082
Horseshoe Lifebuoy	Lifebuoy SOLAS Approved 2.7kg	Lifebuoy SOLAS Approved 4kg	Lifebuoy Light LED Nuova Rade	Lifebuoy Light Lalizas	Bracket to Suit Lalizas Lifebuoy Light
					
LHT095	BHW792	SFT124	SFT143	SFT096	SFT192
Lifebuoy Light Comet L90	Bracket to Suit Comet L90 Lifebuoy Light	Comet Lifebuoy Light and Smoke PCMOB2	Pains Wessex Line Thrower 250	Replacement Rocket for Line Thrower 250	Life Jacket Light Daniamant W4-A Alkaline
					
SFT036	SFT084	SFT010PKTBOM	GCH138	GCH179	BHW053
Poly Flare Container Small	Poly Flare Container Large	Marine Safety Pod with Vertical Holder	SOLAS Reflective Tape 50mm x 45.7m Full Roll	SOLAS Reflective Tape 50mm Per Metre	Galvanised Bucket

					
BHW204	SFT039	BHW539	BHW308	BHW572	GCH056
Galvanised Red FIRE Bucket	Life Jacket SOLAS Approved	Sea Anchor Small 650mm	Sea Anchor Large 1350mm	Sea Anchor Extra Large Heavy Duty 2000mm	Air Horn Gas Operated 250g
					
GCH071	ELC093	BHW048	BHW484	GCH220	GCH221
Air Horn Gas Operated Small 50g	Horn Single Trumpet S/S 12/24V	Radar Reflector Standard Tube 600mm x 50mm	Radar Reflector Large Tube 600mm x 100mm	Navigation Day Shape Sphere	Navigation Day Shape Diamond
					
PL4254					
Navigation Day Shape Cone					

FLARES

Required by both commercial and most recreational vessels alike, we recommend and supply the Pains Wessex range of distress signals. All signals, built to SOLAS specifications are designed to work in the freezing temperatures of the Southern Ocean, all the way to the warmth of the tropics – even after being immersed in water.

Features

- > Rocket flares eject a red parachute up to 300m high which burns for 40 seconds.
- > Smoke flares emit a bright orange smoke, helpful for location and determining wind direction during daylight hours.
- > Red hand flares burn brightly for 60 seconds, allowing rescuers to pinpoint location by day or night.



LRSPPARA

Parachute Red Rocket Day & Night Use



LRSFLAHS

Orange Hand Smoke Flare Day Use

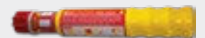

LRSFLRHAND

Red Hand Flare Day & Night Use



LRSFLACAN

Orange Can Smoke Day Use



SFT142

Inshore Flare Kit (2x Red, 2x Orange)





PL2547

Pains Wessex Mob Light & Smoke Safety Device

EPIRB

The ACR 2842 Global Fix Pro 406 is a category I automatic release EPIRB. An automatic release EPIRB is perfect for mounting in an open, out-of-the-way place like the top of a hard top. Automatic, or category I EPIRBs, are designed to be activated when the unit is submerged in water. You can also manually activate the 2842 by flipping the main switch while it is inside or outside of the HydroFix housing or being submerged in water when removed from the housing.

					
PL2974	PL3797	SFT115			
Orange Winter Freezer Boot	Orange Winter Freezer Boot	GLOBALFIX PRO 406 EPIRB AUS GPS Auto float free			
SIZE: 7-13	SIZE: 7-13				

LIFE JACKETS



An approved life jacket must be provided for each person on your vessel when out on the water. In Tasmania, it is compulsory that you wear your life jacket at all times on any motorboat or motor propelled boat under six metres in length whilst underway. A life jacket is also compulsory for any lightweight craft including kayaks, canoes, paddle boards & yacht tenders. Life jackets must be made to Australian Standard AS4758.1.

					
PL1307	PL1310	PL1311	PL1312	PL1316	PL1317
Life Jacket Axis Child 12-25kg PFD100 Yellow + Red	Life Jacket Inflatable Automatic Yoke Axis 150 PFD 1 Red + Grey	Life Jacket Inflatable Offshore Manual Yoke AXIS PFD 1 Red	Life Jacket Inflatable Spare Gas Cylinder 33g Kit	Life Jacket Axis Adult Large 70kg+ PFD1 Yellow + Red	Life Jacket Axis Child 10-15kg PFD100 Yellow + Red
					
SFT130	SFT039	PL1320	PL1321	PL3045	PL3711
Life Jacket Axis Junior 25-40kg PFD100 Yellow + Red	Life Jacket Solas & Coastal Orange	Life Jacket Whistle Pealess Orange	Life Jacket 40kg BLA Yellow	Life Jacket PFD Axis Manual Inflation Waist Belt 100	Life Jacket AXIS Offshore Pro Hammar 150 Automatic Black
					
PL3802	PL4222	SFT144	SFT145	SFT146	SFT147
Auto Inflate Axis Re-Charge Kit For PFD Yoke	Life Jacket PFD Hammer MSEA 150N With Harness Blue	Stormy Life Vest Small Red	Stormy Life Vest Medium Red	Stormy Life Vest Large Red	Stormy Life Vest XL Red

					
SFT148	SFT149	SFT150	SFT151	SFT152	SFT153
Stormy Life Vest XXL Red	Stormy Life Jacket Small Red	Stormy Life Jacket Medium Red	Stormy Life Jacket Large Red	Stormy Life Jacket XL Red	Stormy Life Jacket XXL Red
					
SFT101	SFT102	SFT103	SFT104	SFT105	SFT106
Axis Pilot Jacket PFD Manual Small Red	Axis Pilot Jacket PFD Manual Medium Red	Axis Pilot Jacket PFD Manual Large Red	Axis Pilot Jacket PFD Manual XL Red	Axis Pilot Jacket PFD Manual XXL Red	Axis Pilot Jacket PFD Manual XXXL Red
					
SFT107	SFT108	SFT109	SFT110	SFT111	SFT112
Axis Pilot Jacket PFD Automatic Small Red	Axis Pilot Jacket PFD Automatic Medium Red	Axis Pilot Jacket PFD Automatic Large Red	Axis Pilot Jacket PFD Automatic XL Red	Axis Pilot Jacket PFD Automatic XXL Red	Axis Pilot Jacket PFD Automatic XXXL Red
					
SFT116	SFT133	SFT131	SFT120	SFT121	SFT122
Crewfit Sport Yoke PFD 165N Navy	Axis Yoke PFD Manual Blue	Axis PFD100 Junior Small 15-40kg Yellow + Red	Axis PFD100 Adult Medium Yellow + Red	Axis PFD100 Adult Large Yellow + Red	Axis PFD100 Adult XL Yellow + Red
					
SFT169	SFT212	SFT166	SFT167	SFT168	SFT210
Ultra Raider PFD Level100 Junior Yellow + Red	Ultra Raider PFD Level100 Small Yellow + Red	Ultra Raider PFD Level100 Medium Yellow + Red	Ultra Raider PFD Level100 Large Yellow + Red	Ultra Raider PFD Level100 XLarge Yellow + Red	Ultra Raider PFD Level100 XXLarge Yellow + Red
					
SFT211	SFT117	SFT118	SFT119	SFT170	SFT178
Ultra Raider PFD Level100 XXXLarge Yellow + Red	PFD MSEA Hammer Hydrostatic Workvest 150N Inflatable Yoke Red	PFD Burke Yoke Manual	PFD Burke Yoke Auto	Ultra Auto Inflating Yoke Level 150	Ultra Manual Inflating Yoke Level 150

HYDROSTATIC RELEASE UNITS FOR LIFE RAFTS

We stock and recommend the Hammar range of Hydrostatic Release Units (HRU's). Designed to fit life rafts of all shapes and sizes, they are made of glass fibre reinforced nylon for strength and to prevent corrosion. Hammar HRU's require no servicing, maintenance, or spare parts, you simply install a new one every two years and dispose of the old one. Hammar HRU's are 97% recyclable. **Two models are available for raft capacities between 4-Man to 12-Man and 12-Man and over.**

					
LRSMREL24	LRSMREL01				
Hydrostatic Release Unit (HRU) for Small Rafts	Hydrostatic Release Unit (HRU) for Large Rafts				
COLOUR: Green	COLOUR: Yellow				

13 FISH PEN & MOORING EQUIPMENT

- > Bird Net Stands
- > Anchors for Mooring Systems
- > Marine Markers
- > Mooring Blocks
- > Grid Floats
- > Airfoss - Mortality Removal Unit
- > Net Weights and Diverless Net Weight Hooks
- > Quadrants
- > Shackles and Chain
- > Mooring Grid System Ropes
- > Stanchions
- > Tow Floats
- > Thimbles

We have a track record second to none for designing, specifying, assembling and managing the installation of moorings from single point assemblies to large scale, multi-pen grid systems.

We custom specify mooring systems to particular customer requirements such as locations, sea state and weather parameters working with long term engineering partners we complete a detailed analysis of maximum loads and performance requirements. The experience we have built over many years in deploying mooring systems and monitoring their performance enables us to offer customers total peace of mind.

BIRD NET STANDS

Bird net stands are the centre support frames for circular, square or rectangle fin fish nursery and grow out pens. They are proven designs from High Density Polyurethane (HDPE) with polystyrene (EPS) filled base and support netting off the water allowing the pen to be worked on without interference whilst keeping birds and predators out. Custom designed, we work with you to provide the best solution for the environment, the size and shape of the pen.

Features

- > Proven designs, custom to suit requirements
- > Durable in harsh environments
- > Pre-made in-house and constructed onsite



ANCHORS FOR MOORING SYSTEMS

We primarily recommend and supply patented Stingray anchors. Jeyco is the originator of the world's most efficient drag embedment anchor - the Stingray. Conventional wisdom states that the heavier an anchor and chain, the better the holding power will be. Jeyco reject this idea, maintaining that good design will out-perform dead weight. The Stingray represents the culmination of years of research and development by recognised experts in the field. The result is an anchor that delivers a performance to cost ratio that other anchors find extremely difficult to match.

Stingray anchors are made in several different styles based on the application. For example, the longline version has been designed to pack flat for assembly on site, reducing freight costs considerably. A Stingray anchor can be assembled in seconds, without any special tools being required. Other styles are designed to take account of different application specific requirements.

We can also supply any type of anchor as required. We have supplied many common plough anchors which can be bolted together or fully welded.



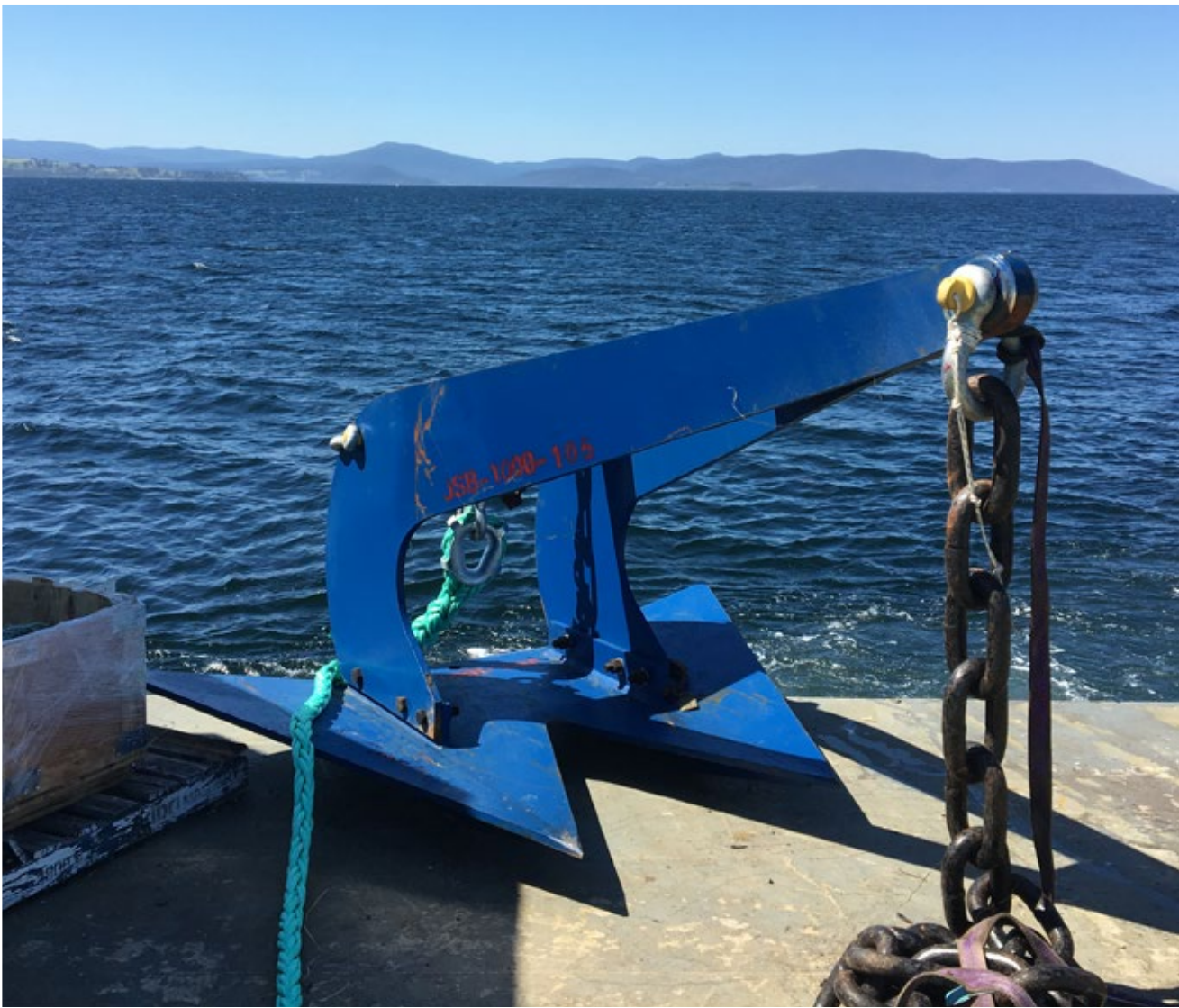

WEIGHT (KG)	HOLDING POWER		
	SAND (TONNES)	MEDIUM CLAY (TONNES)	SILT (TONNES)
10	2.39	1.85	1.34
25	4.95	3.83	2.77
50	8.59	6.65	4.80
75	12.03	9.09	6.57
100	14.91	11.54	8.34
150	20.58	15.93	11.51
175	23.26	18.01	13.01
250	30.89	23.92	17.27
375	42.64	33.01	23.84
500	53.60	41.50	29.97
750	73.99	57.28	41.37
1000	93.00	72.00	52.00
1500	128.37	99.39	71.78
2000	161.36	124.93	90.22
3000	222.74	172.44	124.54
4000	279.98	216.76	156.55
5000	334.32	258.83	186.93



MARINE MARKERS

Corner markers are most commonly used to mark the corners of aquaculture leases. They are rotationally moulded from virgin UV stable HDPE which provides durability and longevity. With the availability to produce the markers in a variety of colours we can produce a range of cardinal markers as per the IALA navigational requirement.

The markers have concrete ballast which keeps them upright. Mooring equipment can be supplied with the markers.

Features

- > Rotationally moulded
- > Durable
- > Range of colours available e.g. yellow, red, green and white
- > UV stable

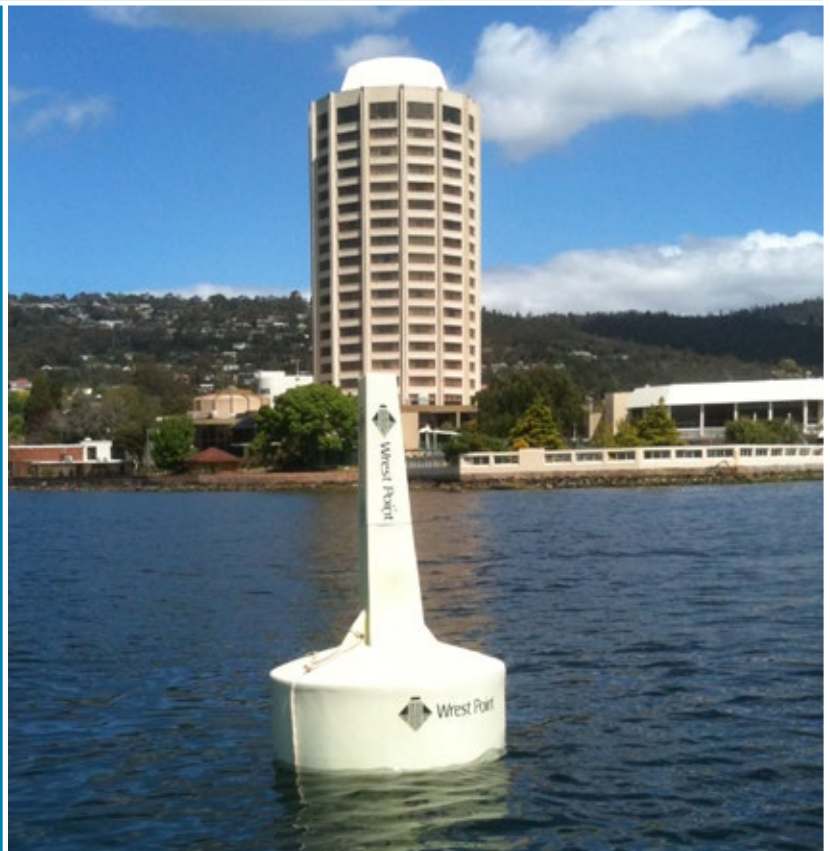

Spar Markers

Designed and manufactured at Seamaster, the Spar Marker can be used as an aquaculture lease corner marker, navigational aid or other marker. They meet the IALA requirements.

Specifically designed for the harsh environment of the southern waters of Tasmania, the markers are 6 metres long and made from 630mm diameter HDPE pipe. The markers are fully sealed without counterweight and are foam filled with internal radar reflection. The mooring attachment is configured so that the mooring rope ties directly to the steelwork at the bottom of the marker, eliminating thimbles, shackles, splicing and corrosion through dissimilar metals. The markers are installed with a “Y” bridle to make installation and adjustment easy (The “Y” bridle can be supplied with the marker or plan of the bridle will be supplied). The markers rely on a taught mooring line to keep it upright with the upward force of buoyance maintaining the line, which provides consistent fixed positioning, without swing on the mooring.

Spar Markers can be adapted as Cardinal Markers for navigation purposes and painted any colour and has internal radar reflectors which is highly visible on radar. Spar Markers can be supplied with or without solar powered lights. Lights can be supplied in a variety of colours and flash patterns along with GPS trackers to ensure position is maintained. Day shapes and crosses with reflective strips can also be supplied as required.

Features

- > Minimal maintenance
- > Maintain an accurate GPS position once set
- > Simple and robust
- > Can be any colour, light and shape configuration
- > GPS monitored
- > Radar detected
- > UV stable

Additional Features/Accessories

- > Powder coated aluminium cross or required IALA shape
- > Sealite or Carmanah light
- > GPS ability
- > Mooring bridle (spliced)
- > Mooring block can be supplied if required



Ocean Spar Markers

The Ocean Spar is a variation of the spar marker and is suited to sites that have extreme high energy, large swell and tidal. The ocean spar marker has 6 metres of 630mm pipe as flotation and an additional 4 metres of 315mm pipe as the light and mark post. This allows for the entire 6 metres of 630mm pipe to be submerged with only the 315mm pipe rising above the surface. This is suited to sites with large swell and/or large tidal variation. It is recommended to use a mooring of at least 2.5 tonnes in water weight (5 tonne concrete block).

Spar Markers can be adapted as cardinal markers for navigation purposes and painted any colour. They have internal radar reflectors that is highly visible on radar. Spar markers can be supplied with or without solar powered lights. Lights can be supplied in a variety of colours and flash patterns. Lights can also come with GPS trackers to ensure position is maintained. Day shapes and crosses with reflective strips can also be supplied as required. They meet the IALA requirements.

Features

- > Minimal maintenance
- > Maintain an accurate GPS position once set
- > Simple and robust
- > Can be any colour, light and shape configuration
- > GPS monitored
- > Radar detected
- > UV stable
- > For very exposed sites or sites with a large tidal rise/fall

Additional Features/Accessories

- > Powder coated aluminium cross or required IALA shape
- > Sealite or Carmanah light
- > GPS ability
- > Mooring bridle (spliced)
- > Mooring block can be supplied if required



MOORING BLOCKS

The concrete mooring block range is available in various sizes and configurations with weights ranging from 500kg to 5 tonnes and can be custom-made to suit size, weight and shape. The two common configurations are wedge blocks and limpet blocks. Both are intended for aquaculture applications where the load is applied from one direction.

We manufacture 3 tonne and 5 tonne wedge concrete blocks, along with sourcing blocks to be manufactured close to site to reduce cost of freighting to sites.

Custom design moulds for concrete mooring blocks are also available upon request.

Features

- > Made with 30mpa concrete
- > 38mm bar used for staples



PRODUCT CODE	DESCRIPTION	WEIGHT
MRH190	Concrete Mooring Block - wedge	3 tonne
MRH191	Concrete Mooring Block - wedge	5 tonne
MRH341	Concrete Mooring Block - H	5 tonne
MRH342	Concrete Mooring Block - limpet - staple bar	4.5 tonne

GRID FLOATS

Seamaster in-house manufactured grid floats are designed and created to cope with the harsh environment of the Tasmanian waters. The 1500 litre, 2600 litre and 4200 litre displacement grid floats are rotationally moulded from a UV stabilised HDPE 8mm thick wall and backed with a further polyurethane of 10mm for added strength. The cylindrical design with coned ends softens movement and reduces drag. The grid floats have a fabricated centre to allow for removable steel work, for ease of exchange of hardware.

Features

- > Hollow float with 5 PSI positive pressure
- > EPS filled float
- > 144L oyster float
- > 290L mussel float
- > 1500L grid float
- > 2600L grid float
- > 4200L grid float
- > Other sizes available on request
- > Variety of colours available on request
- > Removable hot dip galvanised steel core
- > 9.5t WWL shackles fit the top
- > 17t WWL shackles fit the bottom

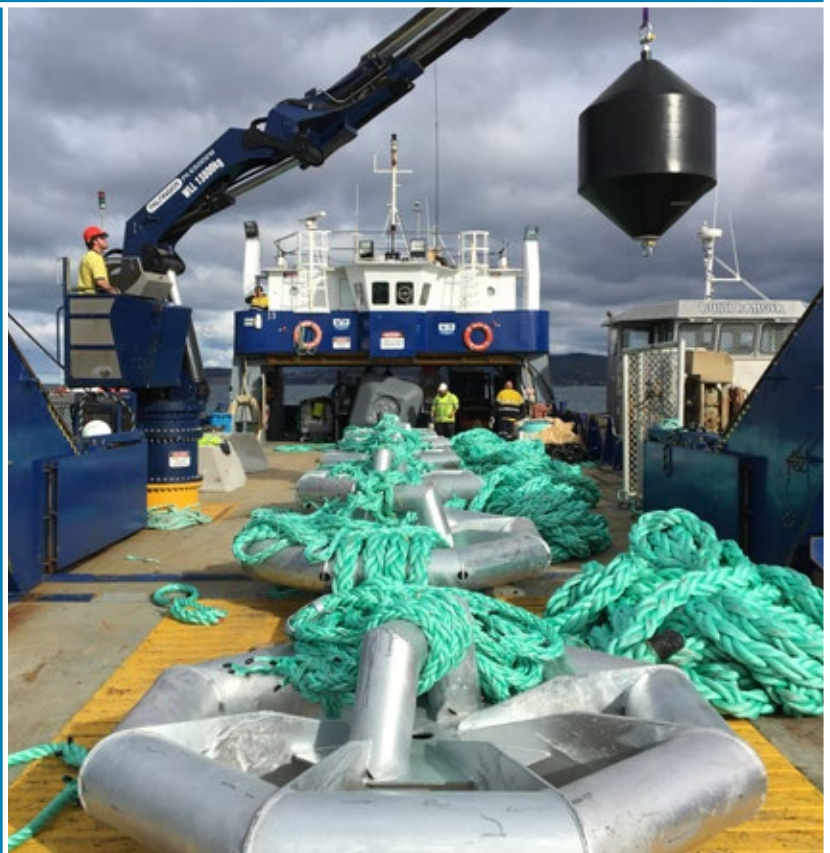

AIRFOSS – MORTALITY REMOVAL UNIT

Seamaster designed and manufactured Airfoss units are a robust system for the removal of mort's from sea pens. Timely removal of mortalities is not only good husbandry but also reduces predator activity.

The Airfoss unit sits at the bottom of the net, mort's fall into the collector pan and pressured air is used to form a vortex to air lift the mort's back to the surface for removal to ensure clean pen environment and live fish health.

Standard Airfoss units comes with the option of up to 400kg ballast within the collector pan, along with customer required air hose fittings.

Features

- > Rotationally moulded with HDPE
- > Telescopic intake funnel, adjustable to suit fish size
- > Steel shot used as ballast to maximise in water weight
- > Built-in sparger for air diffusion
- > Robust design with three lifting eyes
- > Accommodates 200mm discharge hoses, 1/2" or 3/4" BSP air inlet

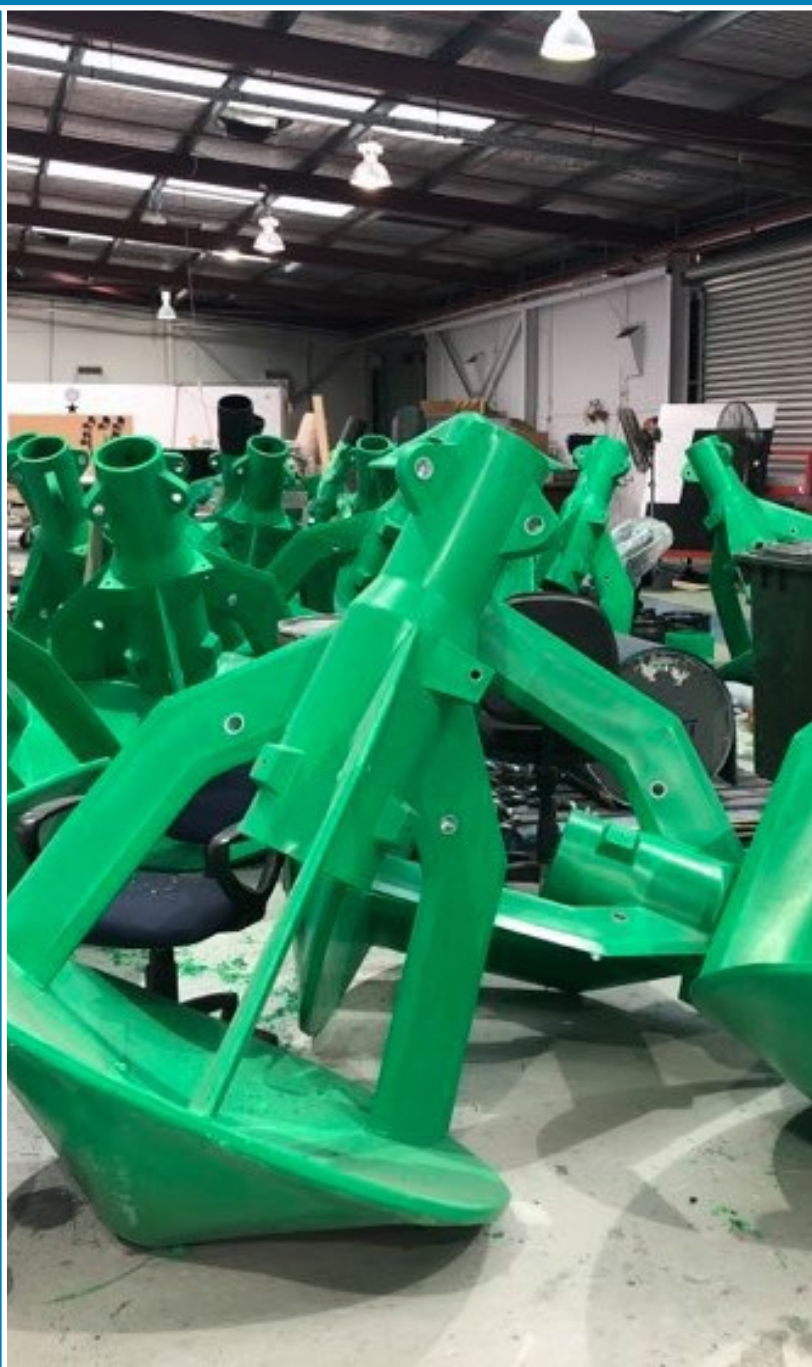

NET WEIGHTS AND DIVERLESS NET WEIGHT HOOKS

The diverless net weight hook is a system used for attaching net weights to nets used in sea pen farming. The hooks can be used with many different styles and weight of net weights to virtually any net depth. The system makes it possible to attach net weights to the base perimeter of a net from the surface without using divers or cameras to install or remove net weights. The hooks can be configured so that the weights are attached close to the net or spaced away from the net. By using the hooks, the full weight of the net weight is supported by the net and not shared with the fish pen, making for more efficient use of the weight and in some cases allowing for smaller weights to be used as compared with other system.

Features

- > Simple robust design
- > Easy to use
- > Supplied with all necessary rigging, with or without net weights
- > Commonly used with weights ranging from 100 to 300kg
- > A larger version has been trialled for cone nets using a 3,500kg weight attached at 55m depth

Additional Features/Accessories

- > Supplied with necessary colour coded ropes cut to length and spliced
- > Can be supplied with net weights



QUADRANTS

The quadrant is used in grid mooring systems as the intersection where ropes join. Traditionally chain plates have been used for this purpose. Quadrants serve the same function as chain plates with several advantages over chain plates by reducing splicing and hardware required, eliminates dissimilar metals, reducing corrosion and allows for easy adjustment of ropes, no need to splice on site. Quadrants are currently available in 3 sizes depending on the size of grid and environmental conditions of the site.

Features

- > Made from hot dipped galvanised steel
- > All ropes tie to the quadrant rather than shackle.
- > Hundreds in use for up to 13 years with no failures



SHACKLES AND CHAIN

Shackles

We can supply any type of shackle up to 85T WLL. The most common shackles we supply are hot dipped galvanised screw pin bow Grade S and comply with the requirements of AS 2741. Mill certificates are available and TUV or SGS reports are available upon request for a minimal added charge. Custom shackles can be supplied but require a minimum quantity and extra costs for moulding.

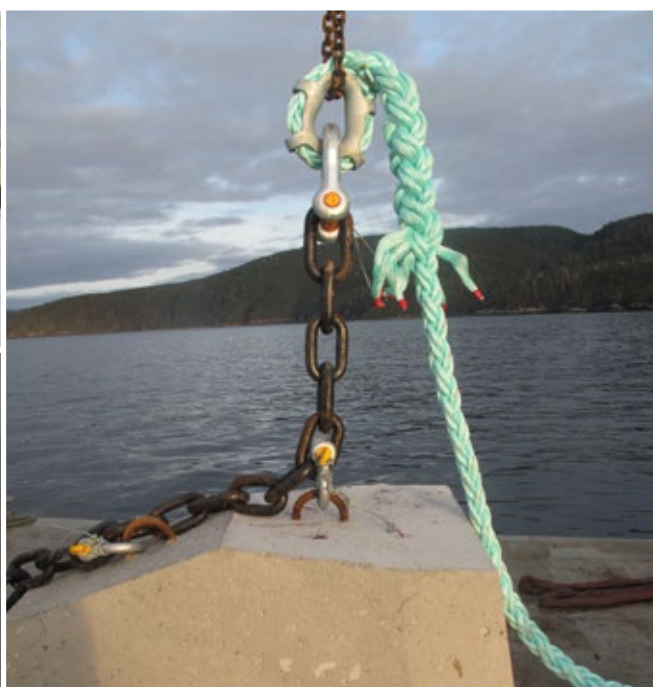
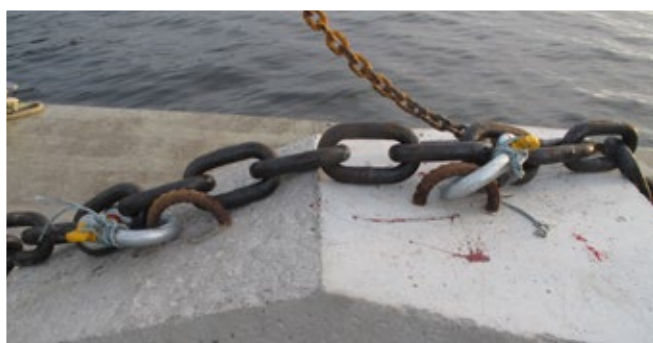

Rated Screw Pin Bow Shackles

PRODUCT CODE		SWL (TONNES)	MBL (TONNES)
MRH166	9.5T Wide Body	9.5	57
MRH136	12T	12	72
MRH137	13.5T	13.5	81
MRH138	17T	17	102
MRH350	25T Wide Body	25	150
MRH002	25T Extra Long Wide Body	25	150
MRH143	35T	35	210
MRH305	55T Wide Body	55	330



Chain

We can supply a large variety of chain ranging from 20mm to 50mm diameter (or bigger on request). We can also supply grade 2 and grade 3 chain in stud link or studless, with enlarged end links if required. Chain can also be supplied in lengths as required. We can get custom lengths from 1m to 55m in many different sizes. Commonly supplied (but not limited to) mooring chains are 24mm, 32mm, 36mm, 40mm and 50mm, which are all available in stud link or open link.

Mooring Chain Features

- > Regular proof coil chain
- > Manufactured from low carbon steel - can be proof tested to at least twice the maximum load recommended for normal use
- > Not suitable for industrial lifting purposes
- > Application: manufacturing, marine and agricultural industries



PRODUCT CODE	DESCRIPTION
CHN004	Chain Studless U2 32mm x 27.5m
CHN027	Chain Studless U2 32mm Per Metre
CHN046	Chain Stud Link U2 50mm x 27.5m Tar coated
CHN047	Chain Stud Link U2 40mm x 27.5m Tar coated
CHN081	Stud Link U2 40mm Tar coated Per Metre
CHN082	Stud Link U2 50mm Tar coated Per Metre
CHN078	Enlarged End Link

Sample chain shown above. More options available on request.

MOORING GRID SYSTEM ROPES

We stock a range of 3, 8 and 12 strand ropes but we recommend 8 strand ropes for fish pen mooring applications. We generally supply Powerdan, Powertex and Powermix ropes ranging from 32mm to 112mm diameter, predominantly in 8 strand construction. We supply rope in coil form (custom lengths available) or in finished form, measured and spliced ready to go in the water. Common sizes we use (but not limited to) are: 40, 44, 48, 50, 56, 64, 72, 85 and 100mm.

The tables below show some common 8 strand sizes we supply. Many other diameters are available and coil lengths can be customised to reduce waste. Colour can also be customised to suit requirements.

Powermix

High strength polyolefin and polyester yarn, providing high abrasion resistance. Powermix is a sinking rope.

PRODUCT CODE	DIAMETER (MM)	COIL LENGTH (M)	COLOUR
ROP532	28	220	White
ROP533	32	220	White



Powerdan

Made from high quality polyolefin fibre, this rope offers great tenacity and high strength.

PRODUCT CODE	DIAMETER (MM)	COIL LENGTH (M)	BREAK STRENGTH (KG)
ROP389	22	220	8,200
ROP253	32	220	17,600
ROP274 BLACK + YELLOW	32	250	
ROP529	36	250	22,100
ROP254	40	220	27,500
ROP530	40	250	27,500
ROP531	48	250	38,100
ROP258	52	220	45,200
ROP333	64	220	65,000

Powertex

High strength polyolefin fibre and specially crafted for improved breaking strength and lower elongation.

PRODUCT CODE	DIAMETER (MM)	COIL LENGTH (M)	BREAK STRENGTH (KG)
ROP317	28	250	17,400
ROP507	32	250	22,700
ROP371	38	250	31,800
ROP293	44	250	41,700
ROP519	50	250	52,200
ROP296	56	250	65,000
ROP508	64	250	84,000
ROP516	72	250	106,000
ROP518	85	250	146,000
ROP517	100	250	200,000

STANCHIONS

Seamaster manufacture a range of stanchions, which can be adapted to circular, square or oblong pens for grow out, or nursery pens for a range of species. Pens maybe adapted to most localities from inshore sheltered waters to exposed waters – either tropical or icy waters of the south. Our stanchions are rotationally moulded from HDPE to withstand harsh environments.

Features

- > HDPE rotationally moulded
- > Robust
- > Suitable to warm or cooler waters
- > Variable pipe sizing and handrails
- > 30m pens up to 120m pens
- > Circular, square or oblong pens
- > Stanchion hook options for net attachment

PRODUCT CODE	INNER PIPE (MM)	OUTER PIPE (MM)	HANDRAIL (MM)
MK16	315	315	110 or 125
	355	355	110 or 125
	400	355	110 or 125
	400	400	110 or 125
MK18	355	355	110 or 125
	400	315	110 or 125
	400	355	110 or 125
	400	400	110 or 125
MK20	450	450	110 or 125
MK22	400	400	110 or 125
	450	355	110 or 125
	450	450	110 or 125
	500	500	110 or 125
MK24	315	315	110 or 125
	250	250	110 or 125



TOW FLOATS

Originally designed for the tuna industry in Port Lincoln SA, the Seamaster-manufactured tow float continues to be a staple for towing pens within Australia and Japan. The floats assist with the flotation of the front tow edge of a pen under tow to reduce the front edge bull nosing under the surface and reducing the risk of losing fish under tow.

Tow floats are rotationally moulded from HDPE and filled with urethane which assists with strength, reduces risk of the void filling with water and sinking if the float wall is compromised.

Colours commonly used are yellow, orange and black.



CGE030

WEIGHT (KG)	LENGTH (MM)	DIAMETER (MM)
21	750	900



CGE031

WEIGHT (KG)	LENGTH (MM)	DIAMETER (MM)
110	1250	1100



CGE064

WEIGHT (KG)	LENGTH (MM)	DIAMETER (MM)
110	180	1300

THIMBLES

We use high quality marine thimbles with high sides to protect ropes from chafing with chain or a shackle.

The table below shows some common, heavy duty cast, semi-enclosed thimble sizes we use in our mooring systems. We can also supply tubular thimbles, wire and fibre rope thimbles and custom thimbles as required.



PRODUCT CODE	SIZE (MM)
MRH183	32-40
MRH290	42-46
MRH184	48-56
MRH185	56
MRH186	60-66
MRH187	68-72
MRH188	76-80
MRH180	80
MRH310	88-102

14 SHELLFISH

- > Hexcyl Products & Mesh
- > Mussel Rope

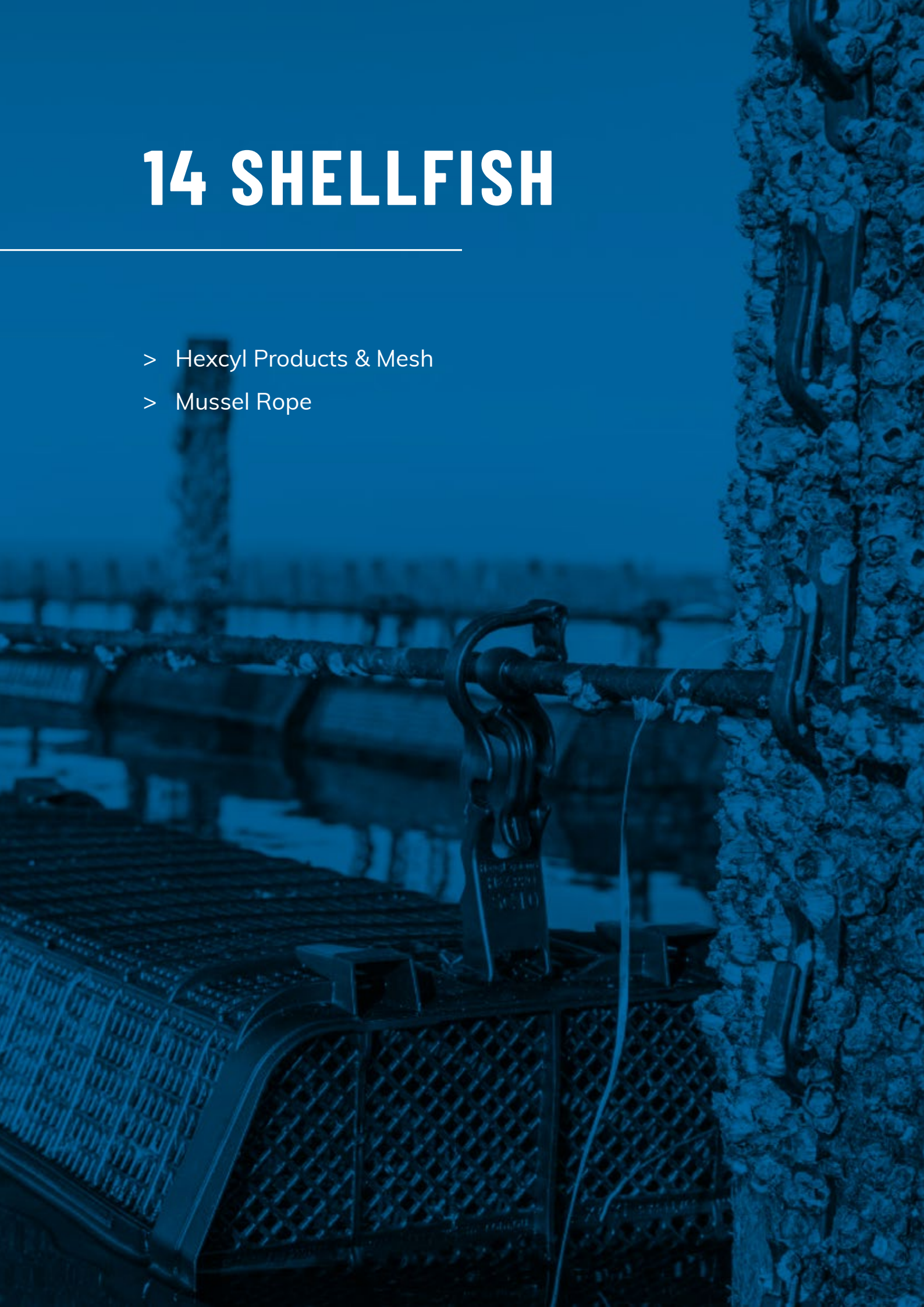

Seamaster is proud to partner with Hexcyl Systems for the distribution of Hexcyl products in South Australia and Tasmania.

Hexcyl's oyster baskets and Long Line Oyster Farming Systems are specifically engineered to excel in the most challenging and demanding environments worldwide.

Hexcyl's oyster baskets and Long Line Oyster Farming Systems are specifically engineered to excel in the most challenging and demanding environments worldwide.

THE HEXCYL PRO 25 LITRE BASKETS & PRODUCTS

The Hexcyl 25 litre baskets offer a durable and versatile product for farming oysters, scallops, and other molluscs in the marine environment. Available in five different mesh sizes, Hexcyl baskets are designed to withstand rough conditions while promoting optimal stock growth and conditioning. Australian made and designed, the Hexcyl 25 litre baskets offer a durable and versatile product for farming oysters, scallops, and other molluscs in the marine environment. Available in five different mesh sizes, Hexcyl baskets are designed to withstand rough conditions while promoting optimal stock growth and conditioning.





SOME OF THE UNIQUE FEATURES AND BENEFITS OF HEXCYL BASKETS AND LONG LINE FARMING INCLUDE:

Durability

The FlipFarm system permanently attaches the baskets to the lines which are 24mm polypropylene rope, tested for 40 years in the New Zealand Greenshell mussel industry. The opportunity for gear loss or damage is significantly reduced. Maintenance on gear is almost eliminated.

Customizability

Hexcyl oyster baskets and long line farming systems can be customized to meet the specific needs of individual farmers, allowing them to optimize their shellfish growing operations.

Versatility

Hexcyl systems can be used in a wide range of environments, from low energy to high-energy tidal areas, making them suitable for different types of shellfish farming.

Improved water flow

The unique design of Hexcyl baskets and farming systems allows for improved water flow and circulation, which can lead to better growth rates and higher yields.

Easy to use

Hexcyl systems are easy to install and maintain, which can save farmers time and money.

Eco-friendly

The use of Hexcyl systems can reduce the impact of shellfish farming on the environment, as they are made of recyclable materials and can be used for multiple growing cycles.

Overall, Hexcyl oyster baskets and long line farming systems offer a range of benefits that can help shellfish farmers to optimise their operations and achieve higher yields in a sustainable way.

HEXCYL PRODUCTS & MESH

Hexcyl PRO 25 litre Baskets and Products

Hexcyl 25 litre baskets offer a durable and versatile product for farming oysters, scallops and other molluscs in the marine environment. Available in five different mesh sizes, Hexcyl baskets are designed to withstand rough conditions while promoting optimal stock growth and conditioning. Australian designed and made.



					
HEX001	HEX002	HEX003	HEX004	HEX005	PL3687
3mm Mesh 25L Basket	5mm Mesh 25L Basket	10mm Mesh 25L Basket	15mm Mesh 25L Basket	20mm Mesh 25L Basket	Hexcyl suspension Clip 9mm
15pc/box 360pc/pallet	15pc/box 360pc/pallet	15pc/box 360pc/pallet	15pc/box 360pc/pallet	15pc/box 360pc/pallet	105pc per Box
					
FSH0066	FSH0693	PL4034	FSH0067	FSH0118	FSH0119
Hexcyl suspension Clip 10mm	Post riser Clip Designed to suit 13mm wear reduction sleeve.	Hexcyl Retro suspension Clip Suits 9mm oyster tube.	Hexcyl Retro suspension Clip Suits 10 - 11.5mm Oyster Tube.	Oyster Tube 10.8mm Overall Diameter	Wear Reduction Sleeves 200mm (long) X 13mm ID
105pc per Box	400pc per Box	150pc per Box	150pc per Box	500m Roll	500pc per Bag

Oyster Mesh and Socks

Our HDPE oyster mesh is a hard-wearing and proven mesh for use in marine and on-land applications. UV stable and supplied in 30m rolls in five mesh sizes.

					
MSH005	PL1536 / PL2609	PL1537 / PL2608	PL1533 / PL1534	MSH003	MSH004
Oyster Spat Mesh Square HDPE 2.0 x 2.0mm aperture x 1mtr high 30m Roll	Oyster Mesh Diamond HDPE 6 x 6mm (9mm diagonal) x 93cm high 30m Roll	Oyster Mesh Diamond HDPE 8 x 8mm (11mm diagonal) x 93cm high 30m Roll	Oyster Mesh Diamond HDPE 10 x 10mm (14mm diagonal) x 93cm high 30m Roll	Oyster Mesh Diamond HDPE 14 x 14mm (18mm diagonal) x 93cm high 30m Roll	Oyster Mesh 17mm x 20mm Diagonal

					
MSH001	PL2645	MSH002	MSH014	MSH015	MSH016
Oyster Socks stretched 8mm black 80cm x 20cm sock 1000pc bale	Oyster Socks stretched 2mm orange 80cm x 20cm sock 1000pc bale	Oyster Socks 10mm black 80cm x 380cm 1000pc bale	BNA Oyster Mesh 20mm x 20mm Square 30m Roll	BNA Oyster Mesh 6mm x 6mm Square 30m Roll	BNA Oyster Mesh 10mm x 10mm Square 30m Roll
					
MSH017	MSH018	MSH019	MSH020	MSH011	
BNA Oyster Mesh 16mm x 16mm Square 30m Roll	BNA Oyster Mesh 20mm x 20mm Square Per Metre	BNA Oyster Mesh 6mm x 6mm Square Per Metre	BNA Oyster Mesh 10mm x 10mm Square Per Metre	BNA Oyster Mesh 16mm x 16mm Square Per Metre	

MUSSEL ROPE

Donaghys complete range of spat collection and crop ropes cover every area of mussel farming supplying high yields and high catch and retention rates. Donaghys rope coupled with a continuous long line system are used for commercial mussel hatcheries where mussels are raised from seed and nurtured under strict quality and environmental conditions, then transferred to suspended lines in deep water. This vertical integration program ensures a sustainable and reliable supply of mussels.



Open Water Crop Rope

Designed specifically for open water mussel farming
18 months development and field trials
Special Aqua trim reduces biofouling
'Fibtrim' allows multiple attachment points
Highest loop density available
Fully balanced construction



Aqualoop Crop Rope

Cost effective brother to open water
Ideal for high tidal areas
Special Aqua trim reduces biofouling
'Fibtrim' allows multiple attachment points
Fully balanced construction



Super Xmas Tree Rope

Ideal for sheltered waters
Straight trim reduces crop damage during harvest
Economical construction
High quality UV stabilised yarn
Fully balanced construction

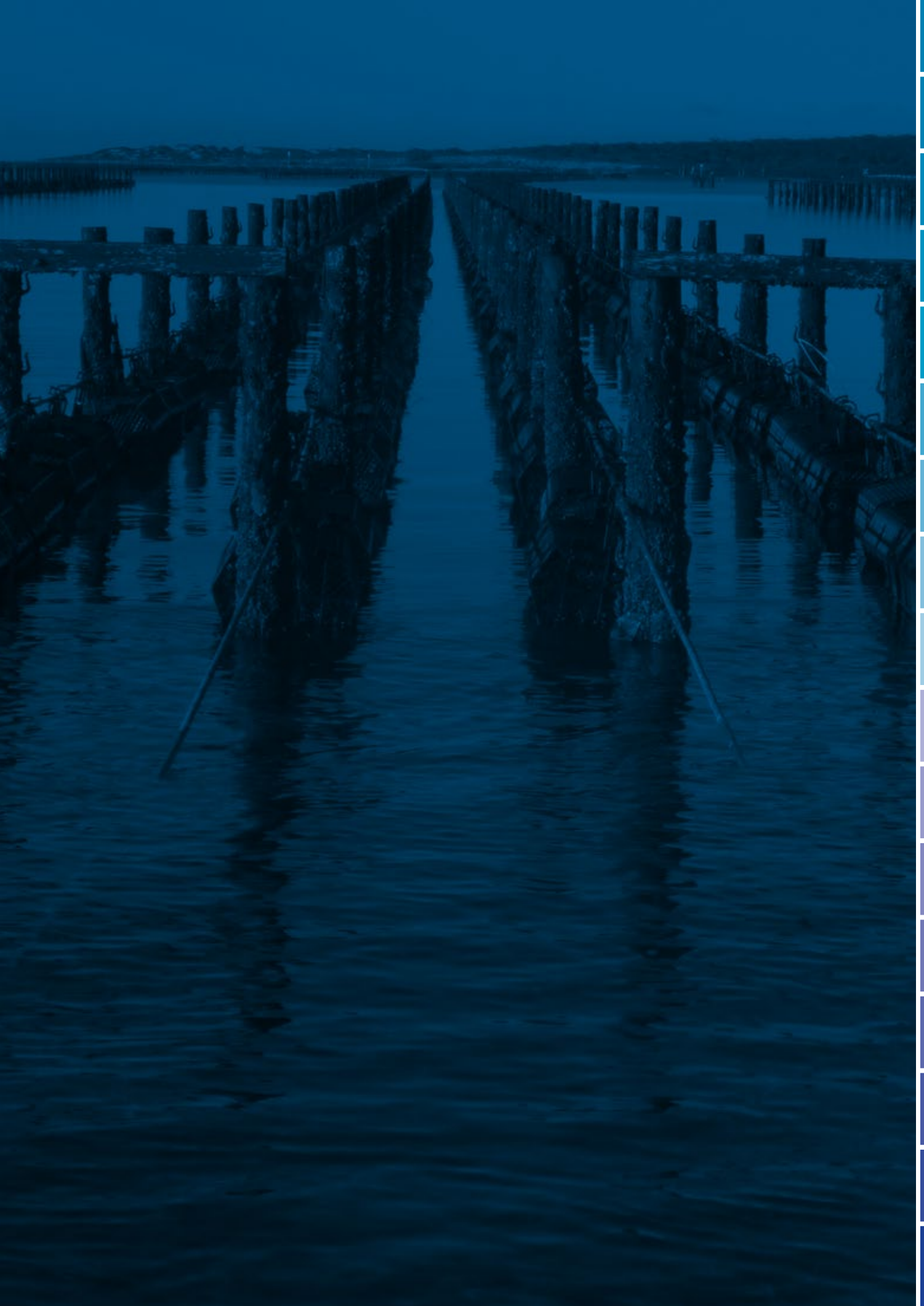

15 STORAGE

- > Collapsible Bins
- > Insulated Bins
- > Non-Insulated Bins, Buckets, Crates, Trays and Drums
- > Pallets
- > Polybench
- > Spill Bunds

Seamaster supply a large range of storage and transport solutions for the seafood, viticulture, agriculture, and domestic industries.

We have been supplying rotationally moulded, durable, fully insulated storage, processing, and transport bins to Australia's largest aquaculture companies for almost 15 years.

Built to Australian Food Grade Standard 2070:1,8, and Potable Water Standards AS4020; these bins are UV stabilised and filled with urethane to achieve excellent thermal properties.

Designed for fork truck access and stackable with or without the lid, these bins are suited to a wide range of applications.

COLLAPSIBLE BINS

Our fully collapsible Flexi Bin range allows full access or half access to two opposing sides. There are no mechanical catches, which allows it to be safely used and easily cleaned. The pallet base and walls are steel reinforced making it very robust.



Flexi Bin - 1m ³	High Sided Flexi Bin 1.5m ³	Tote Box - 370L
LENGTH: 1160mm WIDTH: 1160mm HEIGHT: 1100mm WEIGHT: 105kg FORKLIFT ACCESS: 2 way OPTIONAL: Lid	LENGTH: 1160mm WIDTH: 1160mm HEIGHT: 1610mm WEIGHT: 120kg FORKLIFT ACCESS: 2 way OPTIONAL: Lid, Forklift Rails	LENGTH: 1140mm (open and collapsed) WIDTH: 570mm (open and collapsed) HEIGHT: 570mm (open) 225m (collapsed) WEIGHT: 16.5kg FORKLIFT ACCESS: 2 way

INSULATED BINS

Seamaster supplies a range of insulated bins, made in house. These are robust with 6mm PE, insulated with polyurethane foam walls for optimum temperature control.

Features

- > Rotational moulded low-density polyethylene (LDPE) construction to withstand the harshest of environments
- > Complies with Australian Food Grade Standard 2070:1,8 and Potable Water Standards AS4020 Both bin and lid are insulated for maximum effectiveness and consistent temperature during use
- > Available in a range of colours
- > Multiple uses – fin fish, viticulture, fruit, shellfish, agriculture and medical
- > Stackable, easy to clean and very low maintenance
- > Option to have your company logo & asset ID number moulded into the bin and lid
- > Stackable, easy to clean and very low maintenance
- > Two 50mm OD drain bungs allow for fast, efficient draining
- > The LDPE contains a fully formulated UV stabilisation package to UV8
- > Available in 680L and 1000L

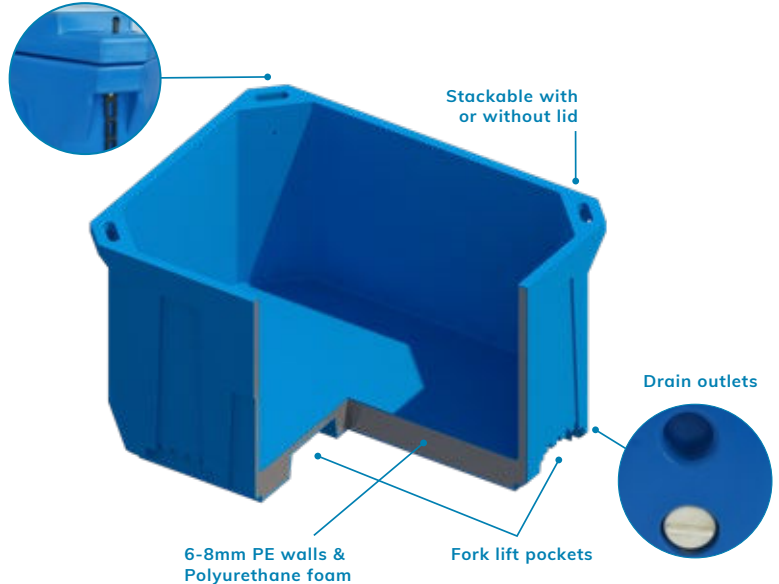

Insulated Bin with Lid
 CAPACITY: 680L
 WEIGHT: 70kg
 Refer to manufacturing colour chart for all available colours.

BIN680

External Dimensions

1230mm L	1030mm W	870mm H
----------	----------	---------

Internal Dimensions

1160mm L	970mm W	635mm H
----------	---------	---------



Insulated Bin with Lid
 CAPACITY: 1000L
 WEIGHT: 100kg
 Refer to manufacturing colour chart for all available colours.

BIN1000

External Dimensions

1470mm L	1165mm W	860mm H
----------	----------	---------

Internal Dimensions

1380mm L	1080mm W	710mm H
----------	----------	---------

To complete our offering of insulated bins, we also source a quality selection of bins from Alps Synergy, ranging in size from 40L - 1700L.

Common uses are on board boats and inland transportation for fresh fish on ice, at docks for pickling and in the processing industry for storage of chilled foods, on-board open transportation and factory floor where space is restricted.

They are constructed of high-insulated foam that helps keep product cold up to five days when properly iced and are accessible by hand pallet jack and forklift truck from two sides.

Features

- > Smooth, curved surfaces, strong proven design, heavy duty use
- > Excellent temperature consistency helps keep product cold up to five days when properly iced
- > Optional drain outlets
- > Quality polyethylene and polyurethane materials
- > Stackable with lid on or off
- > 2 or 4-way forklift entry
- > Storage: Stack up to 5 high full or 10 high empty
- > Optimal transport and warehousing sizes
- > One-piece seamless double-walled construction with foam insulation (PUR - Polyurethane)



Insulated Fish Bin M - Series		
	External Dimensions	Internal Dimensions
PL2976 - 660L	1218mm L, 1023mm W, 813mm H	1130mm L, 933mm W, 600mm H
BIN165 - 800L	1180mm L, 1180mm W, 990mm H	1080mm L, 1080mm W, 745mm H
PL0597 - 1000L	1485mm L, 1157mm W, 1000mm H	1385mm L, 1057mm W, 770mm H
BIN166 - 1700L	2250mm L, 1160mm W, 1160mm H	2110mm L, 1020mm W, 850mm H



Insulated Fish Bin Esky S - Series		
	External Dimensions	Internal Dimensions
BIN123 - 300L	1000mm L, 740mm W, 750mm H	856mm L, 660mm W, 540mm H
BIN122 - 450L	1110mm L, 810mm W, 930mm H	925mm L, 705mm W, 710mm H



Insulated Fish Bin Esky F - Series

	External Dimensions	Internal Dimensions
BIN124 - 100L	815mm L, 480mm W, 475mm H	680mm L, 390mm W, 380mm H
PL2660 - 120L	800mm L, 485mm W, 525mm H	690mm L, 410mm W, 440mm H
PL2661 - 200L	975mm L, 580mm W, 600mm H	830mm L, 490mm W, 490mm H
PL2662 - 220L	945mm L, 595mm W, 650mm H	810mm L, 510mm W, 540mm H
BIN126 - 350L	1170mm L, 730mm W, 695mm H	1000mm L, 620mm W, 560mm H



Replacement Bungs

PL2825 - 60 - 350L	Bung to suit Alps 30mm OD
PL0274 - 450 - 660L	Bung to suit Alps 57mm OD
PL4075 - 800 - 1700L	Bung to suit Alps 79mm OD

NON-INSULATED BINS, BUCKETS, CRATES, TRAYS AND DRUMS

If general storage or materials and food handling solutions is what you require, Seamaster is a distributor of Nally and Viscount products. These bins are quality injection moulded products that have a reputation as a product second to none.

Features

- > Cost effective solution for handling and storing a wide range of materials
- > Lightweight, yet rugged enough to give long service life in tough manufacturing, engineering and food handling applications



12L Crate

LENGTH: 360mm (open)
WIDTH: 280mm (open)
HEIGHT: 190mm (open)
WEIGHT: 1.2kg
FREIGHT: Nestable



20L Crate

LENGTH: 730mm (open)
WIDTH: 300mm (open)
HEIGHT: 120mm (open)
WEIGHT: 1.7kg
FREIGHT: Nestable



40L Crate

LENGTH: 900mm (open)
WIDTH: 520mm (open)
HEIGHT: 175mm (open)
WEIGHT: 4.8kg
FREIGHT: Stackable and Nestable



200L Pallet Tote Tray

Designed to fit neatly onto an Australian Standard Size Pallet, the 300mm high walls provide containment of small or loose items. Made of recycled polymer.

LENGTH: 900mm (open)
WIDTH: 520mm (open)
HEIGHT: 175mm (open)
WEIGHT: 4.8kg
FREIGHT: Stackable and Nestable



Produce Vegie Bin

Produced for the snow pea industry in South Gippsland Victoria and ideal for wine grape harvesting minimising grape damage and juice loss. Single wall construction.

1150mm L, 1000mm W, 540mm H
CAPACITY: 400L
WEIGHT: 25kg
FORKLIFT ACCESS: 2 way on longest side
FREIGHT: Stackable and nestable to 8 high for transport



KB 650

Developed specifically with the food industry in mind the KB 650 has unprecedented strength and smooth interior for full cleanability. Double wall construction. Option of a single skinned lid.

1165mm L, 1165mm W, 780mm H
CAPACITY: 650L
WEIGHT: 50kg
FORKLIFT ACCESS: 4 way
FREIGHT: Stackable



Universal Bin

Comprising of a lid, bin and a base, the universal bin is more hygienic than most bins and is available in magnetic plastic for detection in food processing. The total system is stackable and breaks down to a nestable system for economical transport and storage.

1160mm L, 1160mm W
CAPACITY: 900L
WEIGHT: 35-40kg
FREIGHT: Stackable and nestable



KB 1160

Developed specifically with the food industry in mind, the KB 1160 has unprecedented strength and fully cleanable. Option of single skin lid.

1165mm L, 1165mm W, 1300mm H
CAPACITY: 1160L (approx)
WEIGHT: 75kg
FORKLIFT ACCESS: 4 way
FREIGHT: Stackable



KHB 980 Hopper

The Hopper Bin has a conical interior and 200mm square outlet with single skin slide gate as standard. Options of single skin lid, double skin lid or single skin lid with mesh insert for products that need to breathe, cannot sweat, and require the stopping of any potential contaminates.

e.g. almond roasting

1165mm L, 1165mm W, 1370mm H

CAPACITY: 980L (approx)

WEIGHT: 80kg

FORKLIFT ACCESS: 4 way

FREIGHT: Stackable



Dropside Bin

The dropside bin was developed to hold the full capacity of 1160 litres, whilst also allowing easier access to the inside of the bin through the side drop down door.

1165mm L, 1165mm W, 1300mm H

CAPACITY: 1160L

WEIGHT: 75kg

FORKLIFT ACCESS: 4 way

FREIGHT: Stackable



Tri Series

A series of three bins which can be stacked to 2.4m making them ideal for road freight.

1160mm L, 1160mm W, 950mm H

CAPACITY: each bin 700L (approx)

WEIGHT: 30-40kg

FREIGHT: Stackable and nestable



Ultra Bin (1 Tonne)

The Ultra Bin was developed for the potato industry as a single skinned heavy duty bin to hold 1 tonne of product. It can be stackable up to 4 bins high whilst 2 are ideal for transport. It has 1300 litre capacity and includes a double wall at the top for added strength. A optional lid can be added to help this 2 way entrance bin to help fill a number of roles.

1160mm L, 1160mm W, 1350mm H

CAPACITY: 1300L

WEIGHT: 70kg



Lid Rect IH052		
BIN078		●
BIN084		●
External Dimensions		
645mm L	413mm W	

Bin Rect IH512 - 36L		
BIN023		●
BIN024		●
External Dimensions		
525mm L	336mm W	
Internal Dimensions		
430mm L	272mm W	

Bin Rect IH220 - 41L		
Lid Rect IH221		
BIN025		●
BIN102		●
External Dimensions		
520mm L	350mm W	280mm H
Internal Dimensions		
475mm L	325mm W	275mm H



Bin Rect IH078 - 68L		
BIN040		●
BIN041		●
BIN042		●
BIN043		●
External Dimensions		
645mm L	413mm W	397mm H
Internal Dimensions		
597mm L	362mm W	381mm H

Bin Rect IH051 - 52L		
BIN029		●
BIN030		●
BIN031		●
BIN032		●
External Dimensions		
645mm L	413mm W	276mm H
Internal Dimensions		
597mm L	362mm W	266mm H

Bin Rect IH060 - 32L		
BIN015		●
BIN016		●
BIN020		●
BIN021		●
External Dimensions		
645mm L	413mm W	210mm H
Internal Dimensions		
597mm L	362mm W	203mm H



Bin Rect IH305 - 13L		
BIN105		●
External Dimensions		
432mm L	324mm W	127mm H
Internal Dimensions		
387mm L	286mm W	120mm H

Bin Rect IH306 - 22L		
BIN106		●
BIN107		●
External Dimensions		
432mm L	324mm W	203mm H
Internal Dimensions		
387mm L	286mm W	197mm H

Bin Rect IH307 - 32L Lid Rect IH308		
BIN017		●
BIN022		●
BIN080		●
External Dimensions		
432mm L	324mm W	305mm H
Internal Dimensions		
387mm L	286mm W	298mm H
Lid Dimensions		
438mm L		330mm H



Bucket Round N151 - 13.6L		
BIN059		<input checked="" type="radio"/>
BIN060		<input type="radio"/>
Lid Round Natural N148		
BIN092		<input type="radio"/>



Bucket Round N075 - 22L		
BIN063		<input type="radio"/>
BIN064		<input type="radio"/>
Lid Round Natural N073		
BIN091		<input type="radio"/>



Bin Rect MS7800 Solid - 780L		
BIN045		<input type="radio"/>
Bin Rect MS7810 Vented - 780L		
BIN046		<input type="radio"/>
Lid Rect MSLID		
BIN081		<input type="radio"/>
External Dimensions		
1162mm L	1162mm W	780mm H
Internal Dimensions		
1082mm L	1082mm W	650mm H
Lid External Dimensions		
1180mm L	1180mm W	35mm H

Bucket Round S10 - 10L		
BIN058		<input type="radio"/>
Bucket Round S20 - 20L		
BIN062		<input type="radio"/>

Lid Round White S1OLID		
BIN093		<input type="radio"/>
Lid Round White S2OLID		
BIN094		<input type="radio"/>



Chicken Crate Base		
BIN129		
External Dimensions		
730mm L	530mm W	153mm H



Chicken Crate Sections		
BIN130		
External Dimensions		
740mm L	522mm W	137mm H



Drum with screw top lid - 60L		
PL0509		
External Dimensions		
630mm L	400mm W	400mm H



Vented Crate - 66L

BIN038 ●

BIN039 ●

PL2529 ●

External Dimensions

602mm L	420mm W	325mm H
---------	---------	---------



Bin Rect IH539E - 200L

PL2630

External Dimensions

990mm L	660mm W	470mm H
---------	---------	---------

Internal Dimensions

770mm L	440mm W	460mm H
---------	---------	---------



Fish Bin IH065 - 55L

BIN172 ●

External Dimensions

712mm L	442mm W	293mm H
---------	---------	---------



Vented Freezer Tray - 15.5L

PL3360 ●

External Dimensions

600mm L	350mm W	100mm H
---------	---------	---------

Lid for Vented Freezer Tray

PL3700 ●



Water Drum

PL1143 - 20L ●

PL4137 - 20L ●

External Dimensions

330mm L	280mm W	280mm H
---------	---------	---------



Water Drum

PL1144 - 25L ●

External Dimensions

410mm L	280mm W	280mm H
---------	---------	---------

PALLETS

Australian Standard Pallets

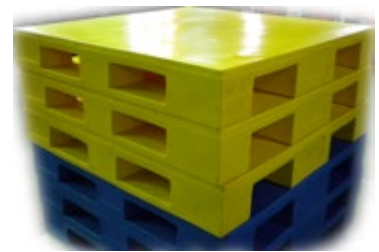

KTAF 1160 (FLAT)

Smooth flat top
1160mm x 1160mm x 150mm
2 way entry weighs 32kg
Steel re-inforced
Beam racking with locks
6 tonne static load
1.5 tonne beam racking load
Stackable

KTAF 1160 (LIPPED)

Smooth top with lipped edges
1160mm x 1160mm x 150mm
2 way entry weighs 32kg
Steel re-inforced
Beam racking with locks
6 tonne static load
1.5 tonne beam racking load
Stackable

KAFW 1160

Smooth flat top
1160mm x 1160mm x 170mm
4 way entry weighs 32kg
Steel re-inforced
Drive-in racking
6 tonne static load
1.5 tonne drive-in racking load
Stackable & conveyable

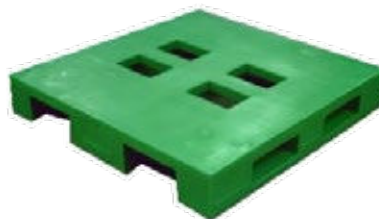

KAFWL (LIPPED)

Smooth top with lipped edges
1160mm x 1160mm x 190mm
4 way entry weighs 32kg
Steel re-inforced
Drive-in racking
6 tonne static load
1.5 tonne drive in racking load
Stackable & conveyable

KAFVW (VENTED)

Smooth top with 4 vents
1160mm x 1160mm x 170mm
4 way entry weighs 32kg
Steel re-inforced
Suitable for Blast Freezers
6 tonne static load
1.5 tonne drive in racking load
Stackable & conveyable

CSLL 1160

Smooth top with lipped edges
1160mm x 1160mm
2 way entry weighs 36kg
Steel re-inforced
Beam & drive-in racking
6 tonne static load
1.5 tonne beam racking load
Stackable



KPT 1160	KDF 1160	CAD 1170
Castellated flat top 1160mm x 1160mm x 180mm 2 way entry weighs 42kg Steel re-inforced Beam & drive-in racking 6 tonne static load 1.8 tonne beam racking load Stackable	Castellated flat top & bottom 1160mm x 1160mm x 180mm 2 way entry weighs 48kg Steel re-inforced Drive-in racking 6 tonne static load 2 tonne drive-in racking load Stackable & conveyable	Smooth flat top 1170mm x 1170mm x 180mm 4 way entry weighs 31kg Steel re-inforced Beam and drive-in racking 6 tonne static load 1.0 tonne drive-in racking load Stackable & suits AGV

Reel Pallets



KRP 859	KRP 1100
Scalloped top Suits 660mm diameter reel 800mm x 590mm 200mm height 10kg weight 2 way entry Aluminium re-inforced Rebates for manual lifter	Scalloped top Suits 1000mm diameter reel 1090mm x 1090mm 250mm height & 31kg weight 2 way entry Steel re-inforced Locking lugs for Beam racking Stackable & includes handgrips

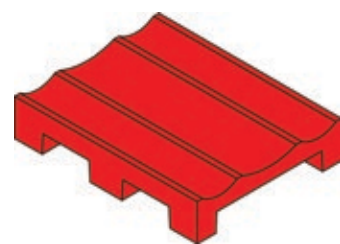
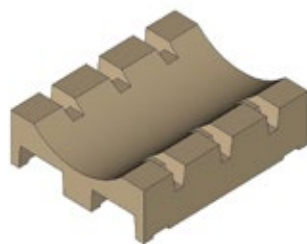

KRP 1080	KMRP
Scalloped top Suits 800mm diameter reel 1010mm x 820mm 270mm height 22kg weight 2 way entry Steel re-inforced Locking lugs for Beam racking	Multiple scalloped top Suits 1 x 750mm diameter reel & 2 x 300mm diameter reels 1000mm x 790mm 200mm height 15kg weight 4 way entry Aluminium re-inforced

European Standard Pallets



KTF 1208 (FLAT)	KTL 1208 (LIPPED)	KTF 1210
Smooth flat top 1200mm x 800mm x 150mm 2 way entry weighs 21kg Steel re-inforced Beam racking with locks 6 tonne static load 1.5 tonne beam racking load Stackable	Smooth top with lipped edges 1200mm x 800mm x 150mm 2 way entry weighs 21kg Steel re-inforced Beam racking with locks 6 tonne static load 1.5 tonne beam racking load Stackable	Smooth flat top 1200mm x 1000mm x 150mm 2 way entry weighs 25kg Steel re-inforced Beam racking with locks 6 tonne static load 1.5 tonne beam racking load Stackable

Other Pallet Sizes

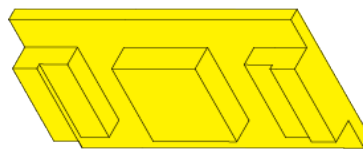
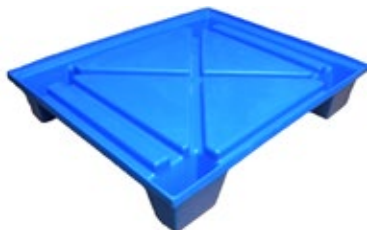

RB 730	KB 600	AB 760
Shape moulded top 730mm x 880mm x 150mm 4kg weight 4 way entry Single skin - no reinforcement Nestable	Smooth flat top 600mm x 1160mm x 150mm 2 way entry weighs 15kg Steel re-inforced Beam Racking with locks 0.5 tonne static load 0.5 tonne beam racking load	Smooth flat top 760mm x 1050mm x 150mm 2 way entry weighs 21kg Steel re-inforced Beam racking with locks 0.5 tonne static load 0.5 tonne beam racking load Stackable



CCLL 7563	KTF 1000	KTL 1220
Smooth flat top 750mm x 625mm x 130mm 9kg weight 2 way entry Aluminium re-inforced Stackable	Smooth flat top 1000mm x 1000mm x 150mm 21kg weight 2 way entry Steel re-inforced 3 tonne static load Stackable	Smooth top with lipped edges 1220mm x 1220mm x 155mm 2 way entry weighs 35kg Steel re-inforced Beam racking with locks 6 tonne static load 1.5 tonne beam racking load Stackable



KTF 1220	KTL 1240	CE 1320
Smooth flat top 1220mm x 1220mm x 155mm 2 way entry weighs 34kg Steel re-inforced Beam racking with locks 6 tonne static load 1.5 tonne beam racking load Stackable	Smooth top with lipped edges 1240mm x 1240mm x 155mm 2 way entry weighs 37kg Steel re-inforced Beam racking with locks 6 tonne static load 1.5 tonne beam racking load Stackable	Smooth flat top 1320mm x 1200mm x 180mm 4 way entry weighs 39kg Steel re-inforced Drive-in racking 6 tonne static load 0.6 tonne drive-in racking load Stackable & conveyable

POLYBENCH

The Polybench is made of food grade polyethylene. It is ideal for storage or display with a height of 300mm. The design allows for easy wash-down cleaning and provides a safe non-absorbent surface that won't harbour dangerous bacteria. The added height allows for cleaning floors underneath, great when used for freezer storage of meat tubs. The Polybench is movable by hand pallet truck or forklift.



Polybench - 1200L

LENGTH: 1200mm
WIDTH: 600mm
HEIGHT: 300mm
WEIGHT: 22kg

SPILL BUNDS

Designed to last, our B1100, K2IBC, B250 & K2DB utilise a steel inner membrane encased in a UV resistant polyethylene skin on their top decks. Our B250 drive in and B80 products include a steel inner frame within the body for added strength.

Features

- > We have the facilities to recycle our pallets and re-use the ground down plastic.
- > Don't bin old products, send them back and let us break it down as reusable powder.
- > You can also ask for recycled content in your next order.



B80 SPILL BUND

1160mm x 1160mm x 150mm
 4 Way
 Suitable for Dexion racking
 Economic bunding suitable for smaller or odd drums which require storage off the floor
 80 litre sump
 Internal steel frame

K2DB SPILL BUND

600mm x 1200mm x 510mm
 2 Way with Forklift pockets
 250 litre sump
 Small footprint
 Ideal for 2 x 200 litre drums
 Will fit nicely against a wall or in an out of way location



B250 RACKING BUND

1200mm x 1200mm x 300mm
 2 Way accessible
 250 litre sump
 Ideal for 4 x 200 litre drums
 Internal steel frame
 Can be used for both drive-in and Dexion racking

B1100 IBC BUND

1640mm x 1440mm x 900mm
 2 Way Accessible
 Single IBC bund
 2 steel encased top decks
 1100 litre sump
 Nestable design helps with transport and movement

K2IBC 2 IBC BUND

2400mm x 1400mm x 500mm
 2 Way Forklift pockets
 Double IBC bund
 4 steel encased top decks
 1100 litre sump
 3 drainage points
 Heavy duty outer skin



16 SEAMASTER PREMIUM PRODUCTS

> [Become a stockist](#)

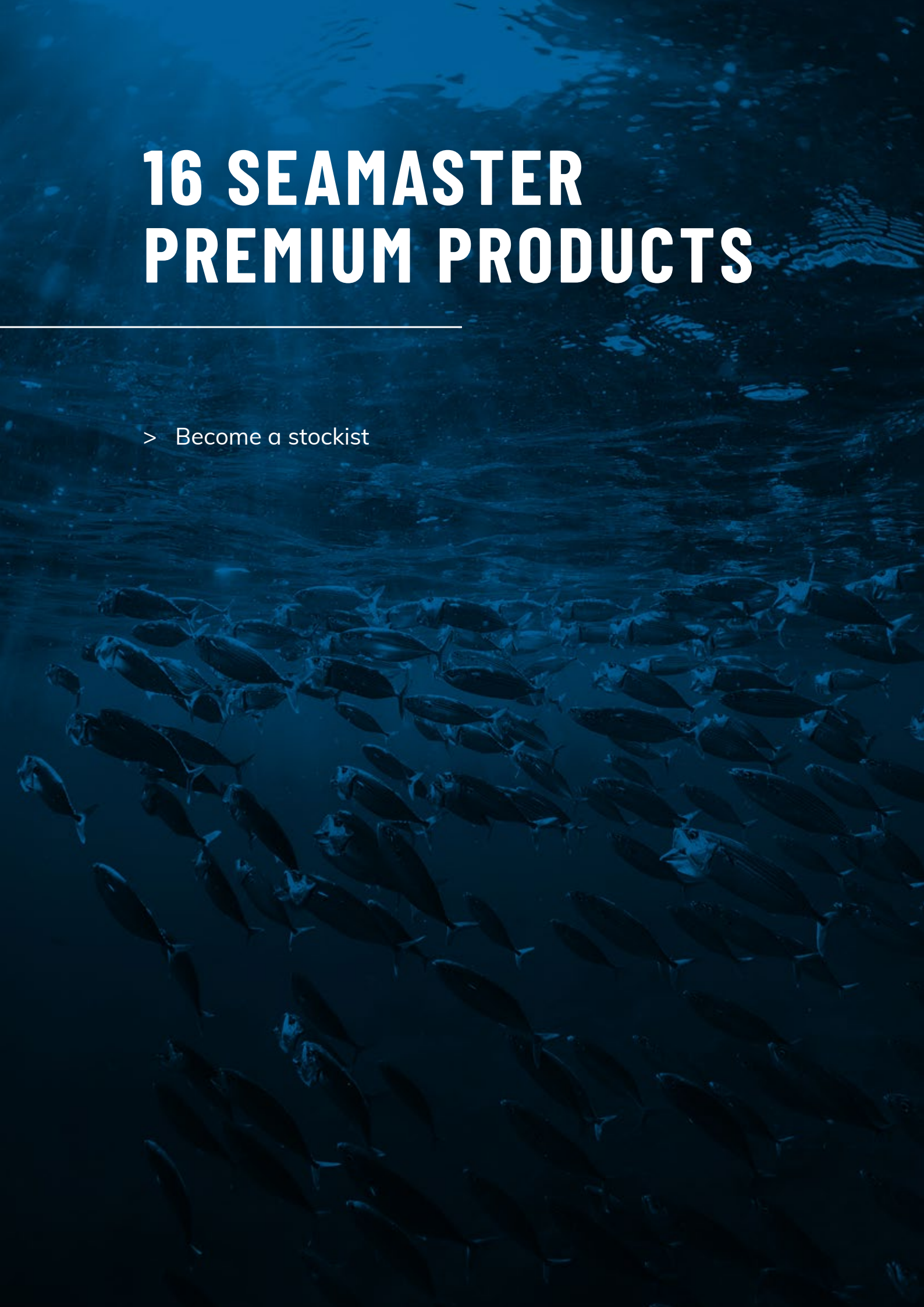

Seamaster extends an exclusive invitation to discerning resellers interested in offering premium fishing gear tailored for the recreational market.

Our meticulously curated product range includes conveniently packaged pre-made rigs such as Stripey, Deep Drop, Mako Shark, and Swordfish, alongside essential items like braid fishing line, deep drop lights, alloy, and copper crimps, as well as top-tier fluorocarbon and monofilament line.

Elevate your clientele's fishing endeavours with Seamaster's exceptional quality and craftsmanship.

Partner with us and embody excellence in the fishing industry.

Join Seamaster today to embark on a journey of unparalleled quality and customer satisfaction.

Contact us at info@seamaster.au



www.seamaster.au